

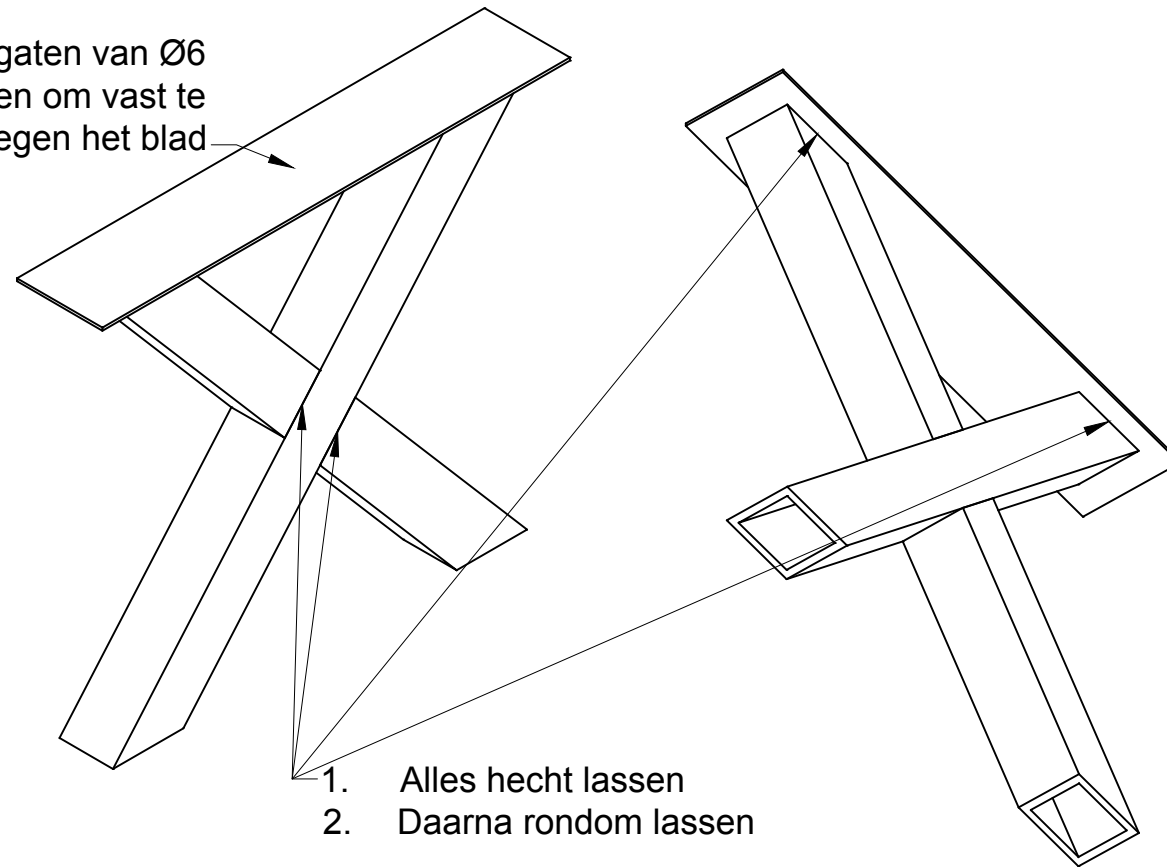

Stap 1

12 gaten van Ø6  
voorzien om vast te  
zetten tegen het blad



Stap 2

1. Alles hecht lassen
2. Daarna rondom lassen

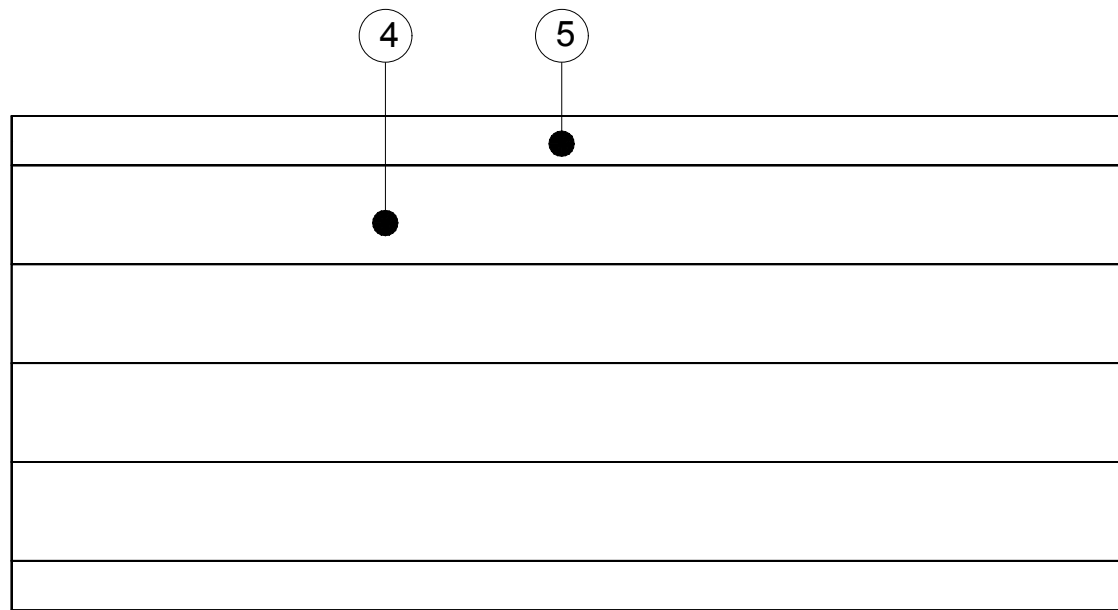
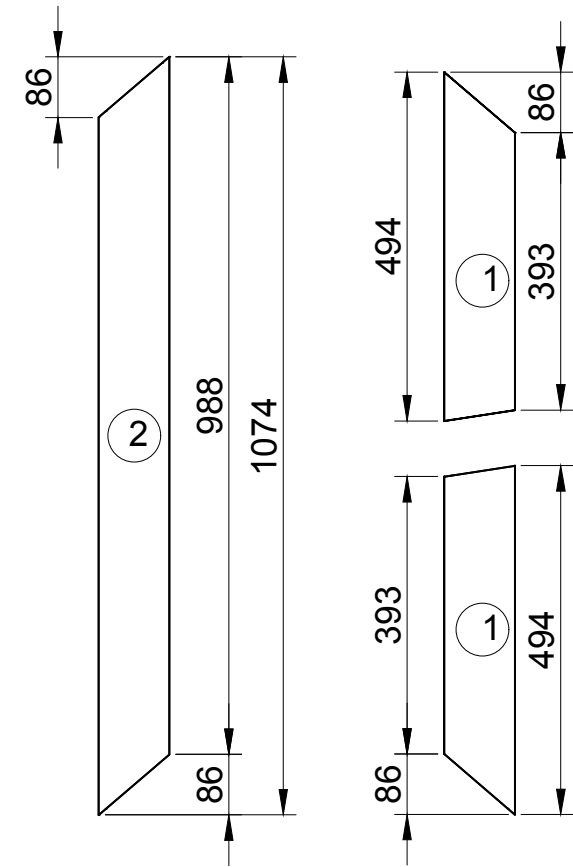

Stap 3

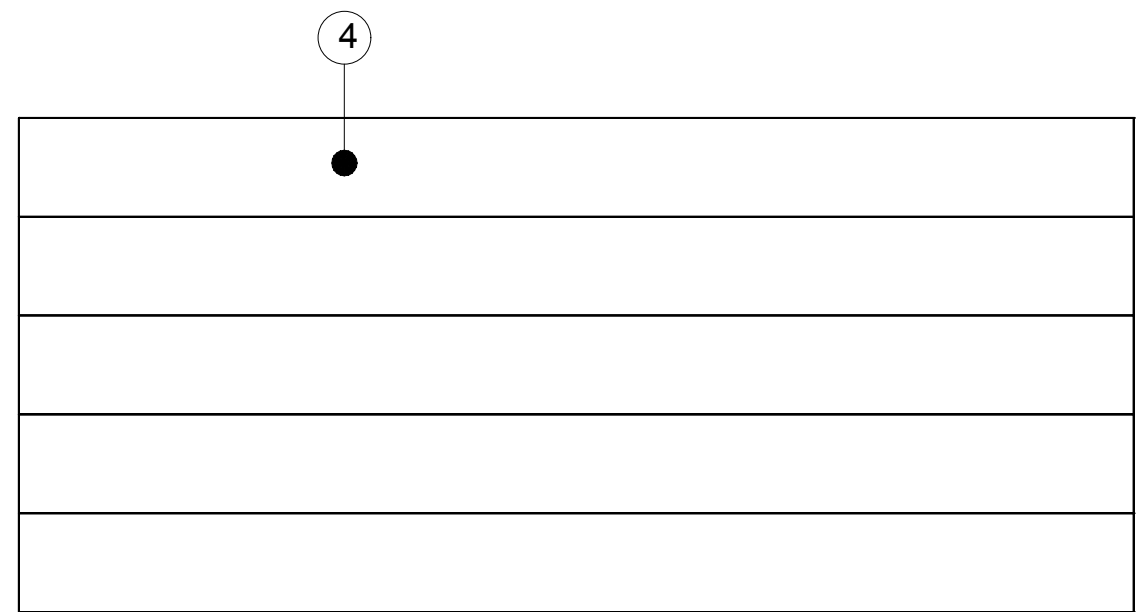

getekend	Fredsbouwtekeningen.nl	1 van 2
Tafel met stalen X poten		A3

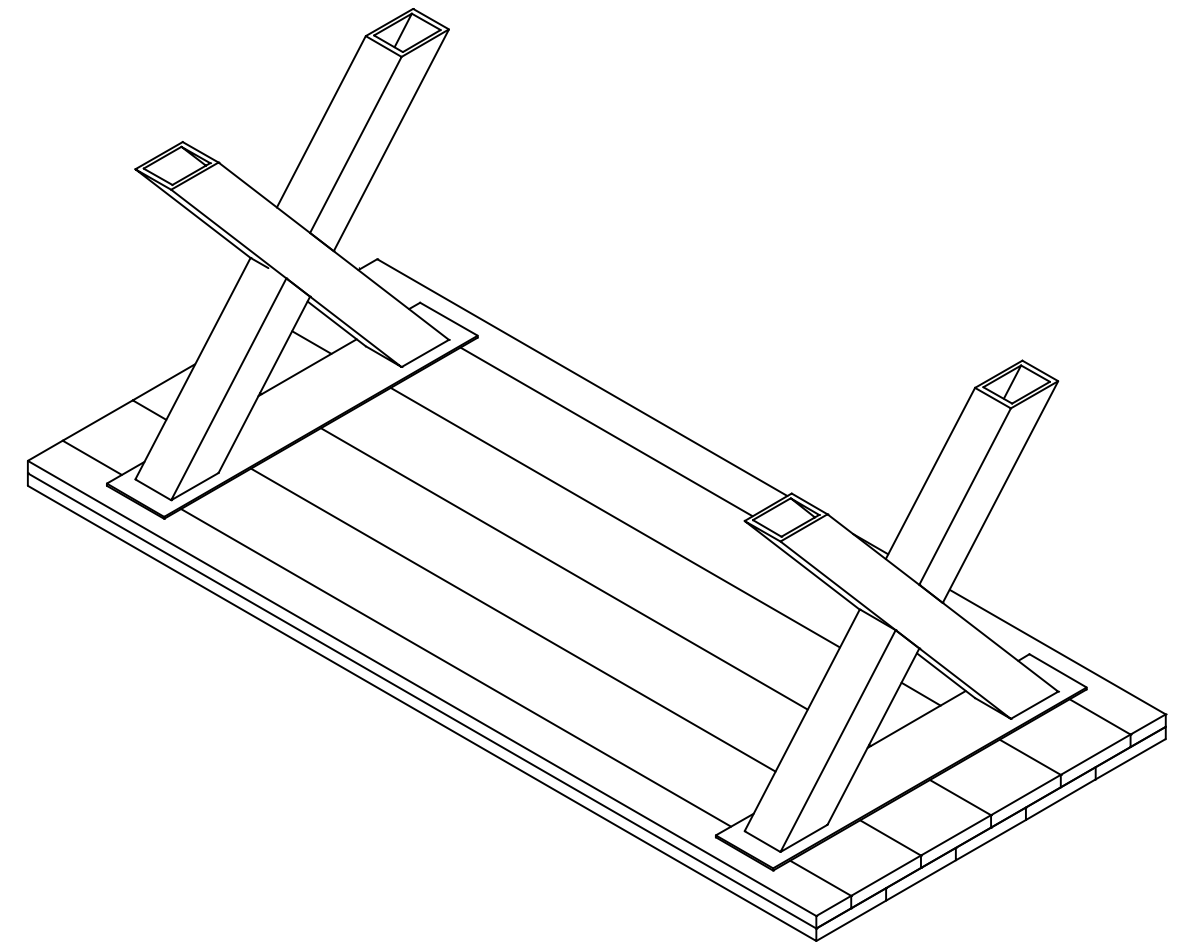

Stap 4

Maat	Lengte	Item	Aantal	Materiaal	Dikte	Breedte	Lengte
Lengte	1800	1	4	Kokerprofiel 100x100x10			494
Breedte	975	2	2	Kokerprofiel 100x100x10			1074
Hoogte	780	3	2	strip	5	160	875
		4	9	Grenen	30	195	1800
		5	2	Grenen	30	97,5	1800
RVS schroeven 5x50 (voorboren)							

getekend	Fredsbouwtekeningen.nl	2 van 2
Tafel met stalen X poten		A3