



Stap 1

12 gaten van Ø6  
voorzien om vast te  
zetten tegen het blad



Stap 2

1. Alles hecht lassen
2. Hoeken moeten goed haaks zijn
3. Daarna rondom lassen

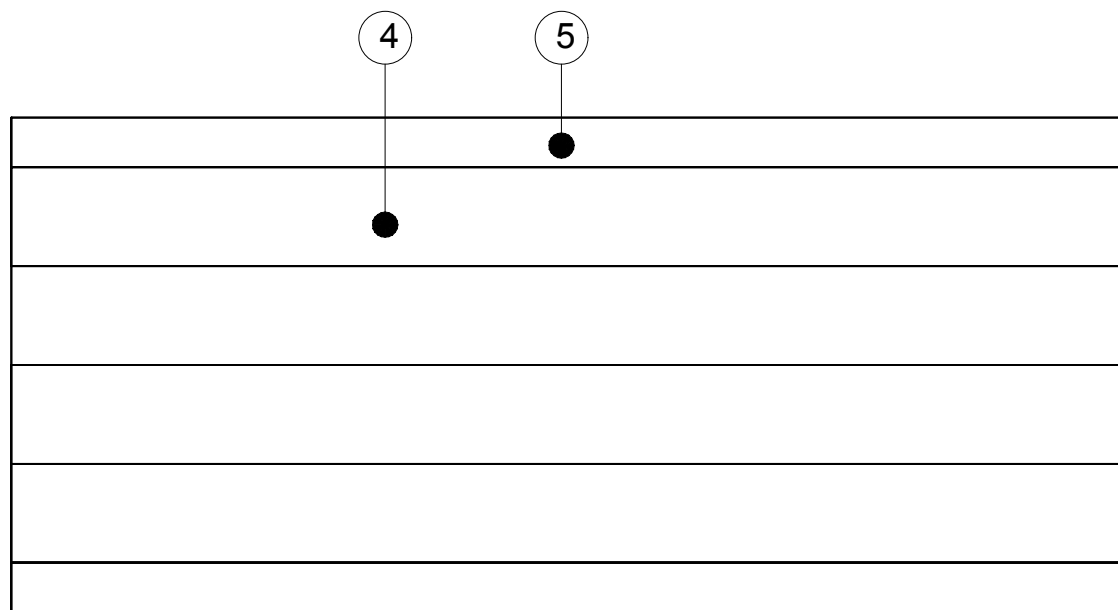

Stap 3

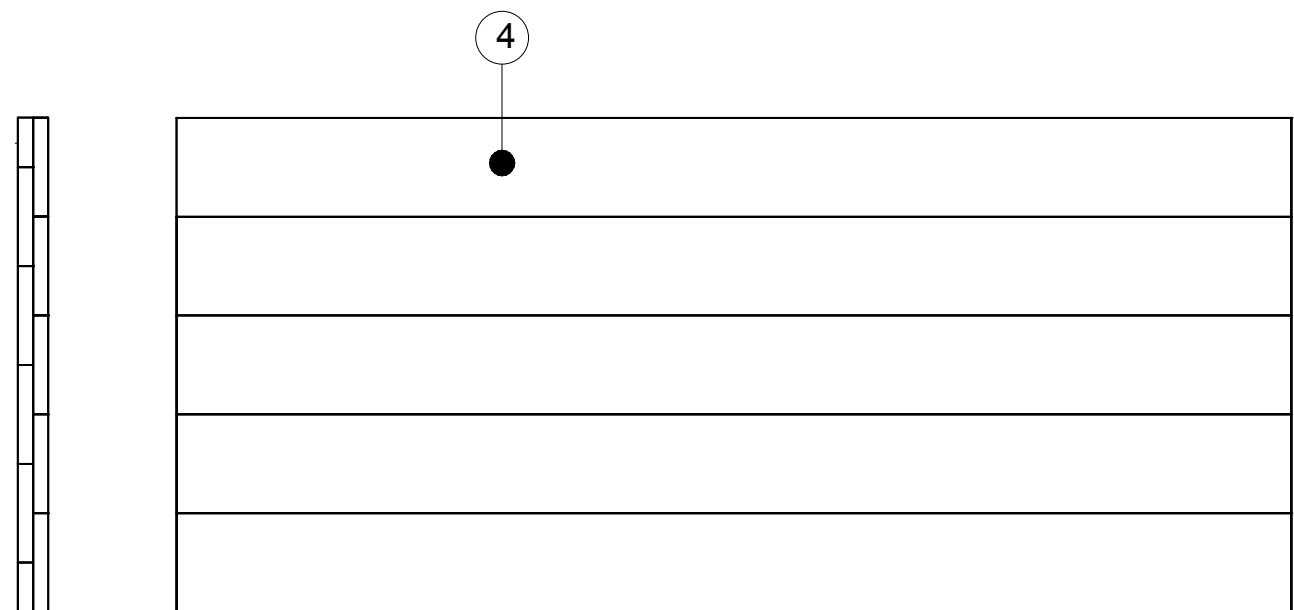

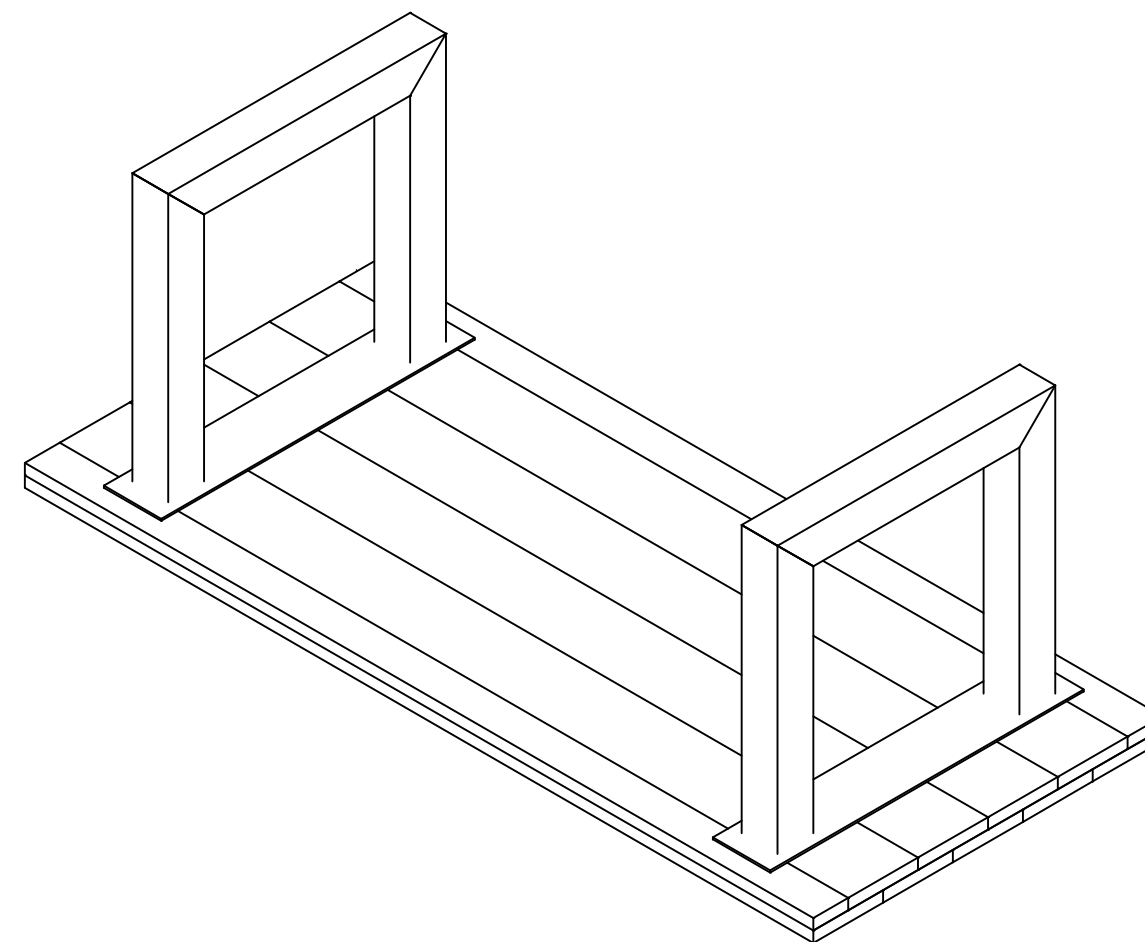
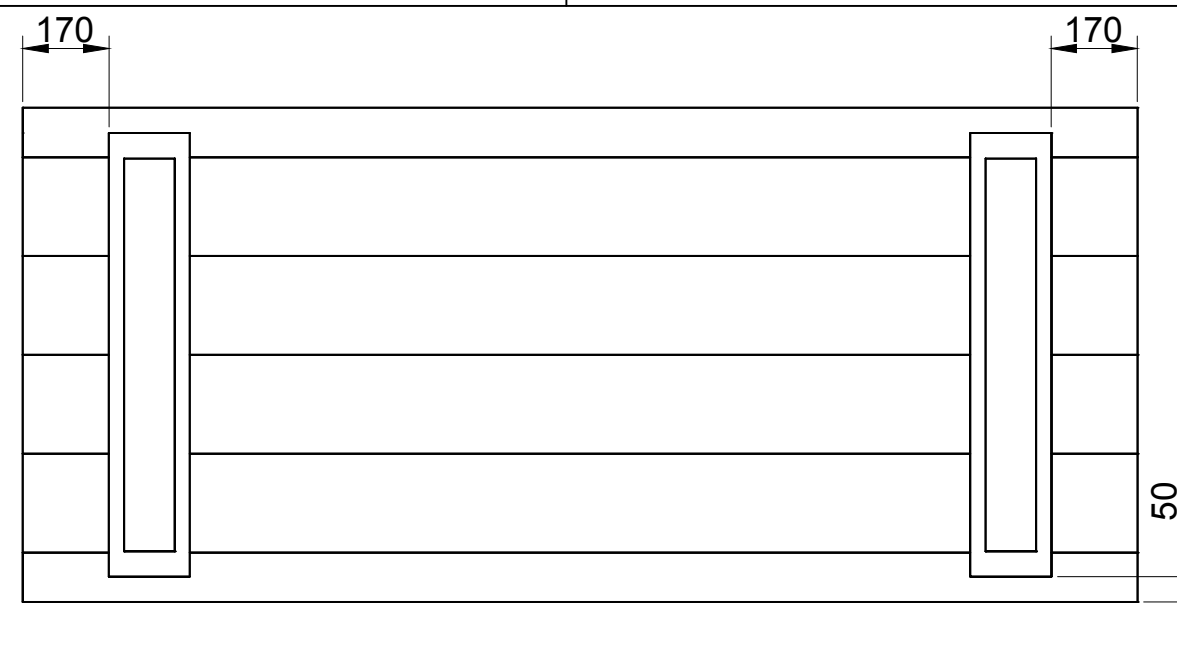
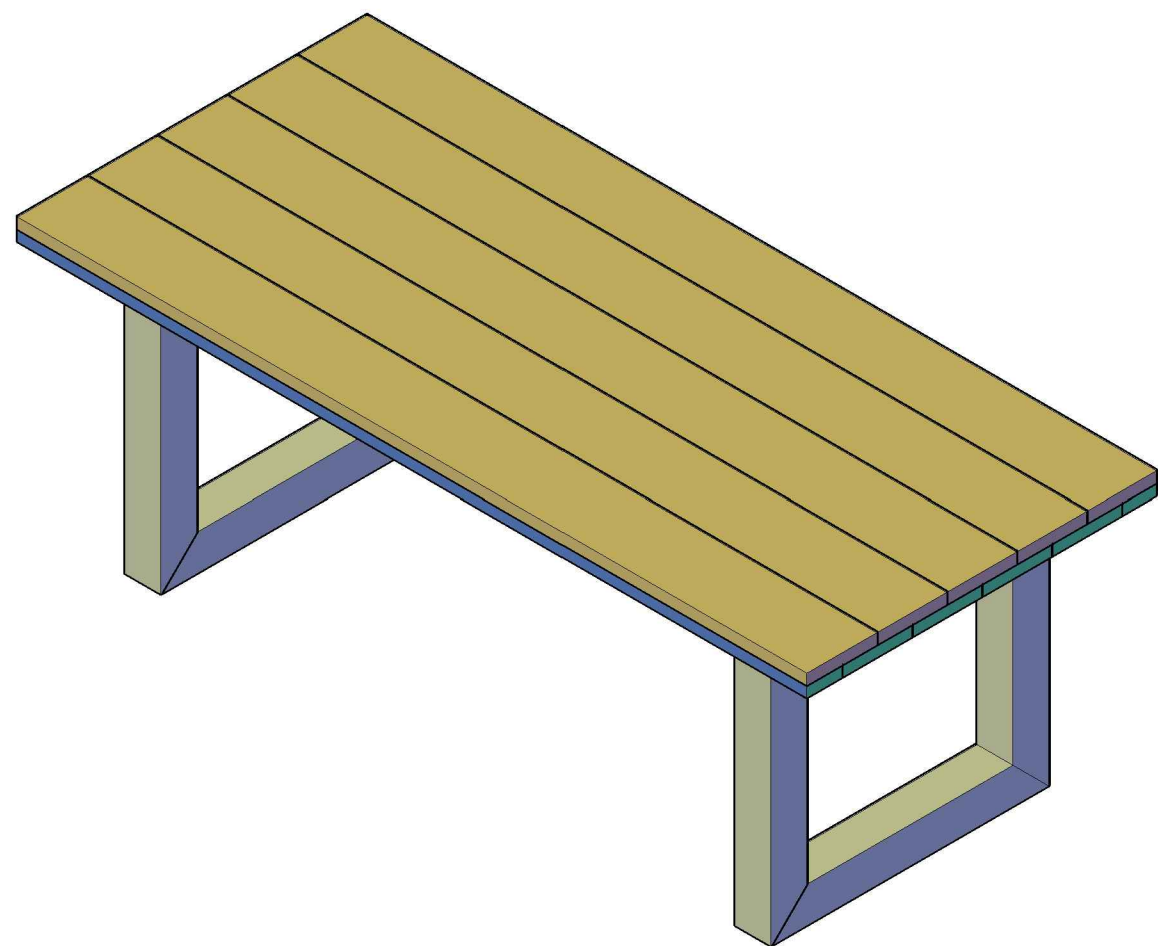

Stap 4

Maat	Lengte	Item	Aantal	Materiaal	Dikte	Breedte	Lengte
Lengte	2200	1	4	Kokerprofiel 100x100x10			715
Breedte	1000	2	2	Kokerprofiel 100x100x10			800
Hoogte	780	3	2	strip	5	160	900
		4	9	Eiken	30	200	2200
		5	2	Eiken	30	100	2200
RVS schroeven 5x50 (voorboren)							

getekend	Fredsbouwtekeningen.nl	2 van 2
Tafel met stalen poten		A3