

Stap 1

12 gaten van Ø6  
voorzien om vast te  
zetten tegen het blad

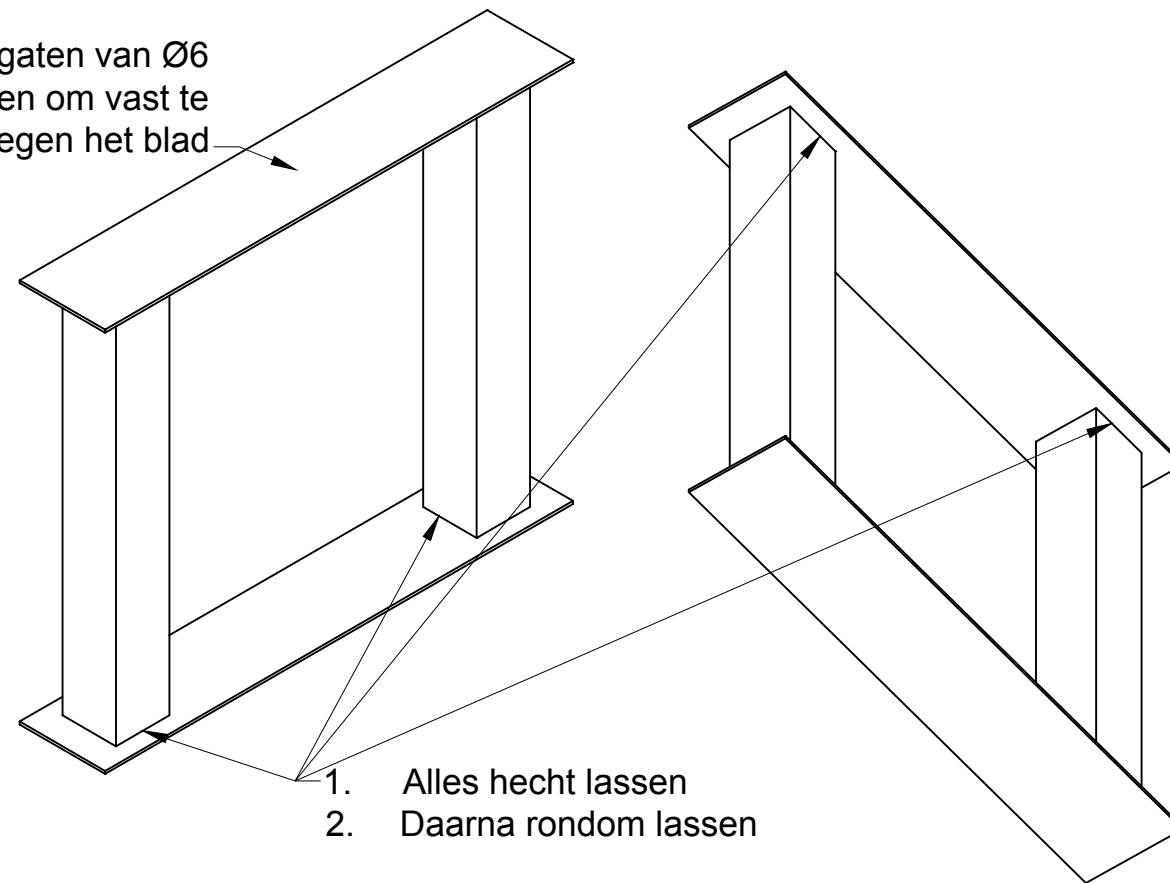

Stap 2

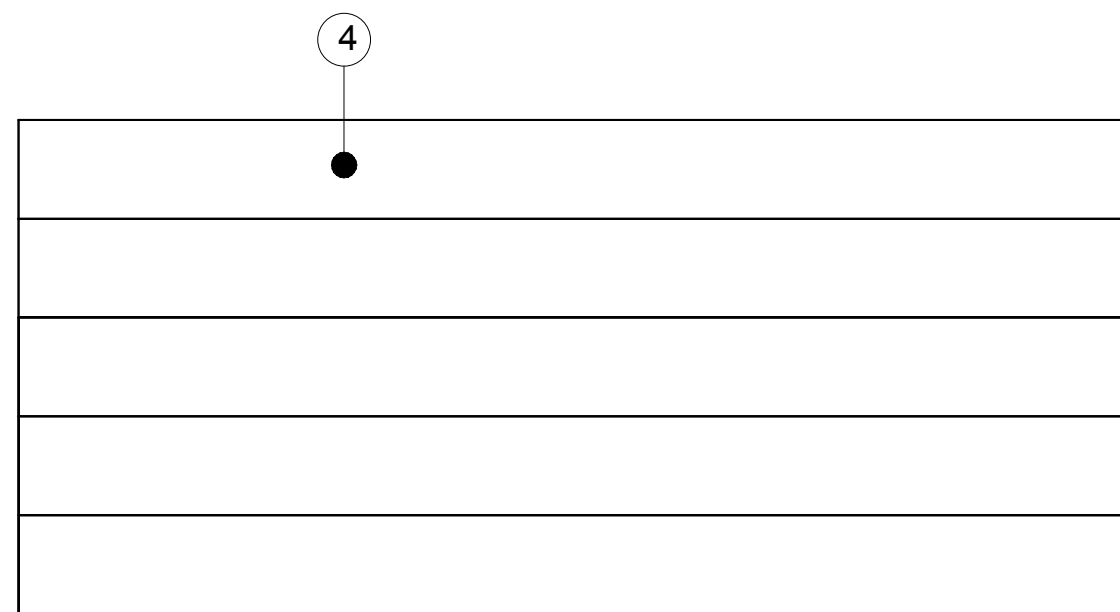
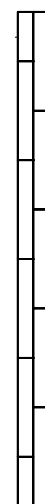
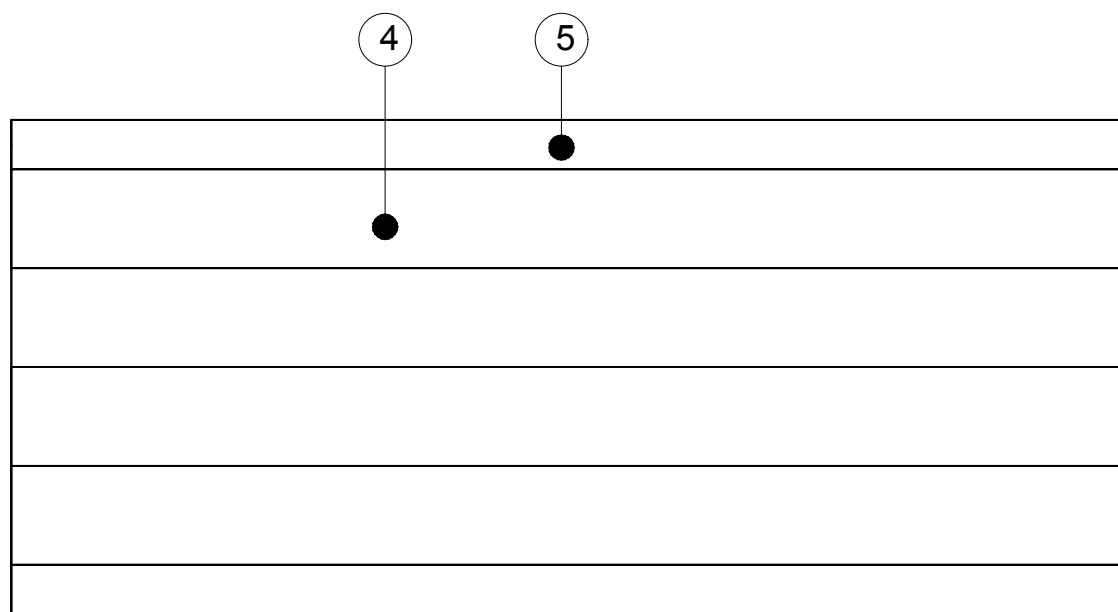

Stap 3

getekend	Fredsbouwtekeningen.nl	1 van 2
Tafel met stalen poten Type B		A3

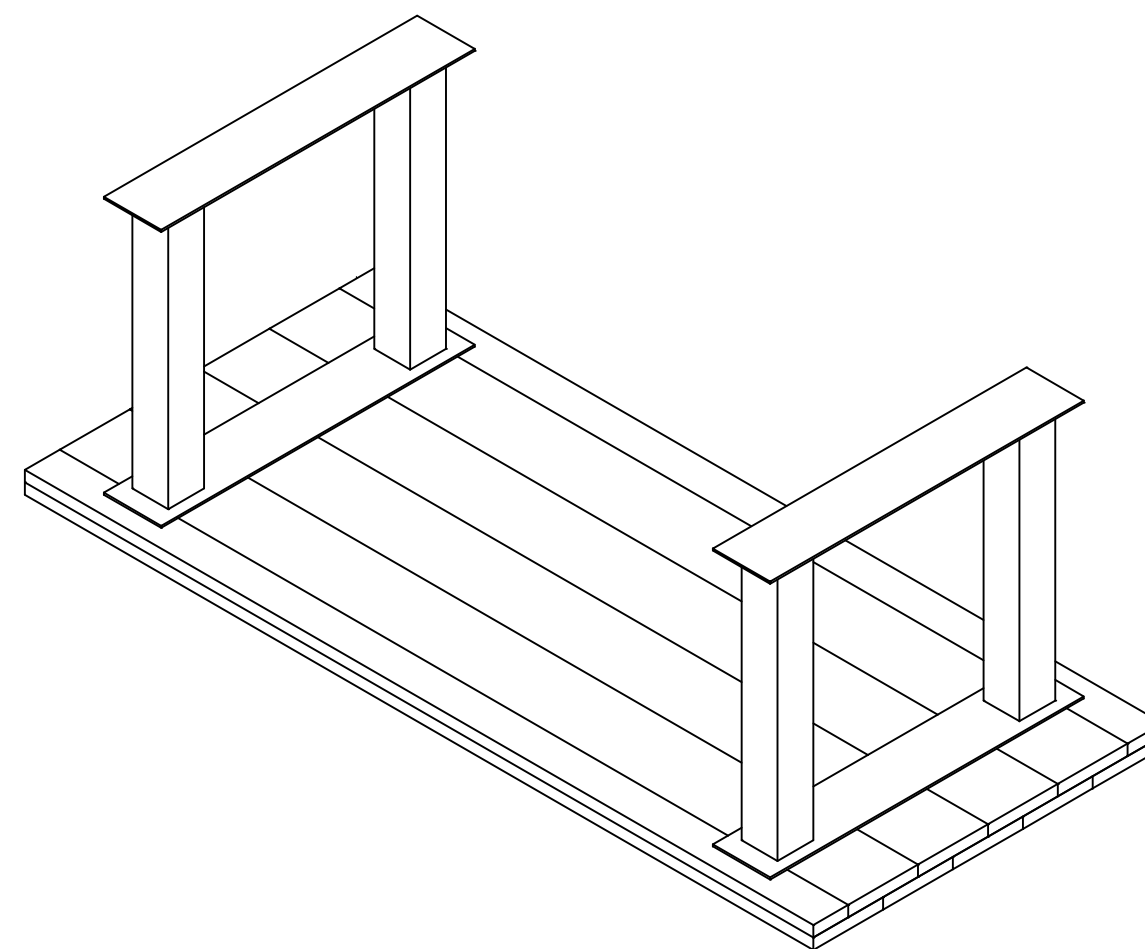
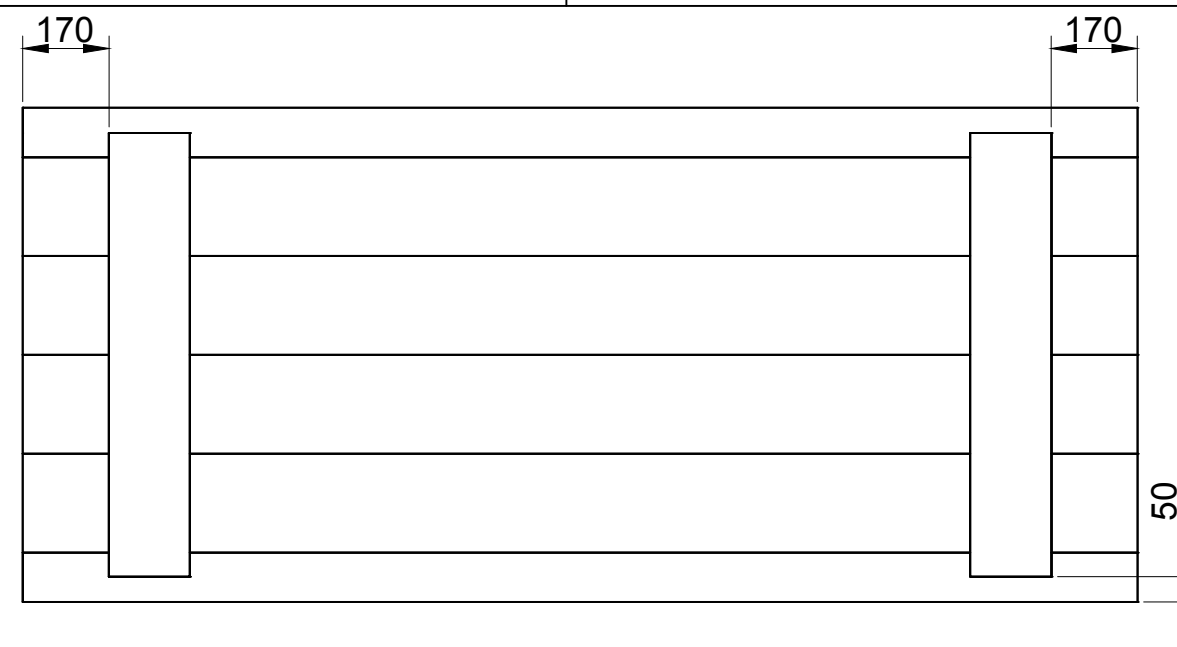
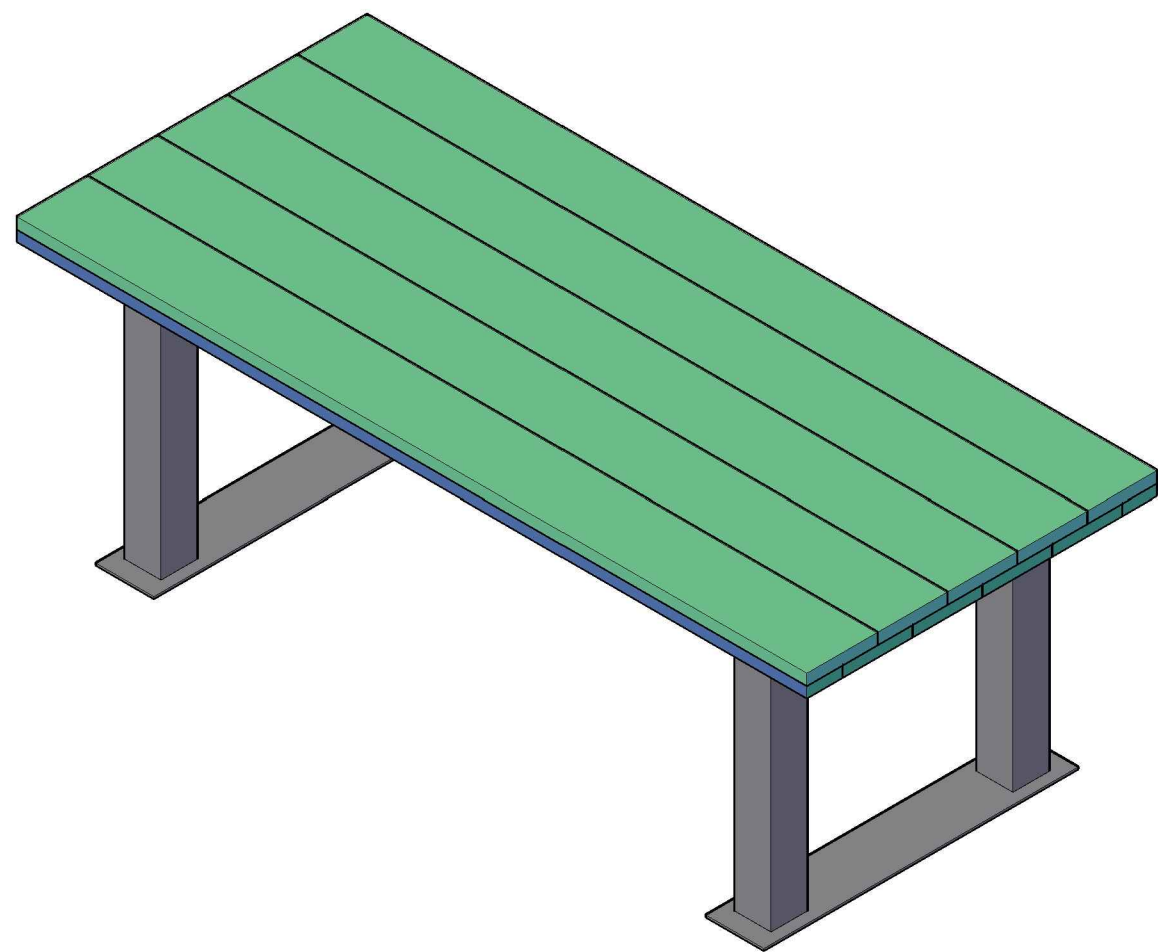

Stap 4

Maat	Lengte	Item	Aantal	Materiaal	Dikte	Breedte	Lengte
Lengte	1800	1	4	Kokerprofiel 100x100x10			710
Breedte	1000	2	2	strip	5	160	900
Hoogte	780	3	2	strip	5	160	900
		4	9	Eiken	30	200	1800
		5	2	Eiken	30	100	1800
RVS schroeven 5x50 (voorboren)							

getekend	Fredsbouwtekeningen.nl	2 van 2
Tafel met stalen poten Type B		A3