

EST. 1901

THE ORIGINAL & STILL THE BEST

The Woodworker

www.getwoodworking.com

& Woodturner

RIDE ON

This motorbike ROCKS!



TURNED LAMP



PALLET CHAIR



CIDER PRESS

- Archive surfboard ■
- Pen turning how-tos ■
- Time travelling saws ■
- Double-up picture frame ■

PLUS: LATEST WOODWORKING NEWS AND TOOLS

mytime media WOODWORKING GROUP



£4.50

Proven tradition and consistent innovation for perfection in woodworking



Thicknessers



Planers



Planer-Thicknesser



Spindle Moulders



Combination Machine

**Spring Discounts
Still Available
Contact Us
01908 635000**



Edgebanders



Wide Belt Sanders



Bandsaws



Clean-Air Dust Extractors



Panel Saws



Saw Spindle Moulder

Tel: 01908 635000, info@felder-group.uk, www.felder-group.co.uk
Joplin Court, Crown Hill, MK8 0JP MILTON KEYNES

Welcome

Now I'd be the first to admit that I'm not the most tidy or organised of workers, but I get the job done and that, when all's said and done, is the most important thing in my book. Despite suggestions from plenty of concerned parties to employ one type of clever scheme or another, my workshop remains in a state of unreadiness and much of my time is spent in – often fruitless – searches for tools, kit and parts various.

Having someone else around to help is definitely a good thing; but despite the best of intentions, there are occasions where poor communication can lead to the same sorry scenario of a vital implement going astray. Fortunately though, there's everybody's favourite solution, The List. Let's face it, lists are great. We've all grown up with lists, from childhood shopping lists for mum, through the teenage dreamer's wish list and the ever-expanding to-do list of adulthood, right up to the I-won't-remember-it-otherwise of the present day.

Making a list should be second nature to any woodworker, especially once a project has passed the design stage and the correct quantities of materials need to be sourced and then prepared for working. As the job progresses, I find it also helps to make a list of the order of play and then perhaps the last few stages that need completing. We recently fitted a sizeable job in London, and to make absolutely sure of a successful installation, the list of essential kit turned out to be one of the longest I've prepared for quite a while. It was worth it though: we didn't forget anything, and, although not everything went as planned, I'm pleased to report that it all turned out OK on the day.

I'm pretty sure that most difficulties can be sorted out somehow with a list, but, as I'm sure you know, it's only any good if you action every item you write down. Apart from satisfactorily completing the actual task, for a reward you get to cross off each entry (or tick the little box you may have drawn – engineer style – alongside), a not unsubstantial pleasure. So, the next time things seem to be getting away from you or you just need to see the bigger picture again, why not sit down and make a list? And that's exactly what I intend to do, just as soon as I can find my notebook.

Mark

You can contact Mark on mark.cass@mytimemedia.com



The final checkover before crossing the last item off the list: load van and head for home

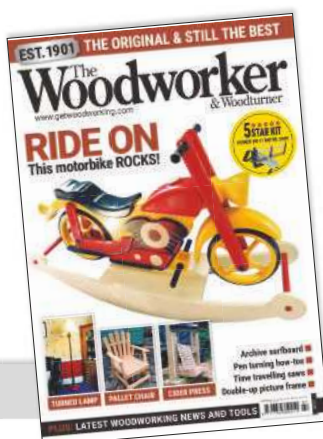

If you can't always find a copy of the magazine, help is at hand! Complete this form and hand it in at your local store, and they'll ensure that a copy of each issue is reserved for you. Some stores may even be able to arrange for it to be delivered to your home. Just ask!

Subject to availability

If you don't want to miss an issue

Please reserve/deliver my copy of *The Woodworker* on a regular basis, starting with issue.....

Title.....First name

Surname.....

Address.....

.....

Postcode.....

Telephone number.....



CONTENTS *What's in store for you this month*

45 WRITING WITH A FLOURISH!

Ian Wilkie's guide
to pen turning



**NEXT
ISSUE**

THE AUGUST ISSUE
IS OUT ON
8 JULY

WOODWORK

14 A chair fit for a king

Andy King puts pen to paper and shows you how to make his popular pallet chair

26 With saw in hand – part 2

Continuing his reflections on sawing by hand, in this issue, Robin Gates explores the idiosyncrasies of vintage saws and makes a simple peg rack to keep them handy

36 Rocking ride

Upon discovering some online plans in German, Derek Lane set about translating these and customising them to meet his requirements for a rocking motorbike for his great grandchildren

52 Short-board

As this excerpt from *The Woodworker* of August 1953 rightly points out, one of the pleasures of a holiday on the North Cornish coast is surfboard riding. Here, we're treated to details of a simple short-board construction using balsa and some fairly sophisticated techniques

54 Picture perfect

Save money and make use of offcuts with a fine double-sided picture frame from Dominic Collings

63 Scrollsawing: a beginners' guide

Roger Berwick reveals six important things to consider if you're looking to take up scrollsawing

66 Pips & cores

Don't let those apples go to waste, says Michael Pooley – celebrate our national fruit by building a cider press

74 The timber in the Wychwoods

Derek Willis examines the historical significance of the Wychwood Forest



14



26



66



TURNING

45 Writing with a flourish!

Ian Wilkie covers the broad subject of pen turning and discusses materials and equipment as well as showing you how to turn your very own 7mm twist ball-point pen

57 The enlightenment

Bob Chapman is commissioned by a friend to make a standard lamp using an old mahogany table top

ON TEST

78 Nobex Do It mitre saw

80 Bosch multi-tool & SDS cutters

82 Veritas detail palm planes

83 Arbortech TurboShaft carving attachment

84 Axminster Trade Series Parrot Vice

REGULARS

3 Welcome

8 AOB & diary

11 Timber directory

13 News from D&M Tools

20 Readers' letters

52 Archive

64 Subscriptions

89 Marketplace

area, how this has changed over the years, and how many are working to protect its conservation and legacy

90 A handful of dust (and this is something all of us woodworkers will be familiar with)

Join us on the back page as we share the first installment of one reader's experiences as a trainee in a busy London furniture factory shortly after the war



74

The Woodworker & Woodturner

July 2016

Published by MyTime Media Ltd
Enterprise House, Enterprise Way,
Edenbridge, Kent TN8 6HF

Tel: 0844 412 2262
From outside UK: +44 (0)1689 869 840
www.getwoodworking.com

SUBSCRIPTIONS

UK – New, Renewals & Enquiries

Tel: 0344 243 9023

Email: help@tw.secureorder.co.uk

USA & CANADA – New, Renewals & Enquiries

Tel: (001)-866-647-9191

REST OF WORLD – New, Renewals & Enquiries

Tel: +44 1604 828 748

CURRENT & BACK ISSUES

Website: www.mags-uk.com

Tel: 01733 688 964

EDITORIAL

Group Editor: Tegan Foley

Email: tegan.foley@mytimemedia.com

Editor: Mark Cass

Email: mark.cass@mytimemedia.com

PRODUCTION

Designer: Nik Harber

Retouching Manager: Brian Vickers

Advertising Production: Robin Gray

ADVERTISING

Business Development Manager: David Holden

Email: david.holden@mytimemedia.com

Tel: 01689 869 867

Online Sales: David Holden

Email: david.holden@mytimemedia.com

Tel: 01689 869 867

MARKETING & SUBSCRIPTIONS

Subscriptions Manager: Kate Hall

Subscriptions: Sarah Pradhan

Tel: +44(0)1858 438 798

MANAGEMENT

Head of Design & Production: Julie Miller

Group Advertising Manager: Rhona Bolger

Email: rhona.bolger@mytimemedia.com

Tel: 01689 869 891

Chief Executive: Owen Davies

Chairman: Peter Harkness

mytimemedia
print & digital media publishers

© MyTime Media Ltd. 2016

All rights reserved ISSN 1752-3524

The Publisher's written consent must be obtained before any part of this publication may be reproduced in any form whatsoever, including photocopies, and information retrieval systems. All reasonable care is taken in the preparation of the magazine contents, but the publishers cannot be held legally responsible for errors in the contents of this magazine or for any loss however arising from such errors, including loss resulting from negligence of our staff. Reliance placed upon the contents of this magazine is at reader's own risk.

The Woodworker & Woodturner, ISSN 1752-3524, is published monthly with an additional issue in summer by MYTIME MEDIA Ltd, Enterprise House, Enterprise Way, Edenbridge, Kent TN8 6HF, UK.

The US annual subscription price is 59GBP (equivalent to approximately 98USD). Airfreight and mailing in the USA by agent named Worldnet Shipping Inc., 156-15, 146th Avenue, 2nd Floor, Jamaica, NY 11434, USA.

Periodicals postage paid at Jamaica NY 11431. US Postmaster: Send address changes to The Woodworker & Woodturner, Worldnet Shipping Inc., 156-15, 146th Avenue, 2nd Floor, Jamaica, NY 11434, USA.

Subscription records are maintained at dsb.net 3 Queensbridge, The Lakes, Northampton, NN4 7BF. Air Business Ltd is acting as our mailing agent



When you have finished with this magazine please recycle it.

Paper supplied from wood grown in forests managed in a sustainable way.



'THE' TOOL SUPERSTORE

HAND, POWER TOOLS & MACHINERY SPECIALIST

DM-TOOLS.CO.UK

YOUR TRUSTED PARTNER

D&M Tools has been family owned and managed since 1978. During that time we have earned a reputation with our customers as a trusted partner. Whether you are a trade professional or a DIY enthusiast, our mission is a simple one - to supply top quality tools at the best value for money, backed up by a service you can trust.

LOW TRADE PRICES!

Whether you're buying online, by phone, email, post or visiting us in-store, D&M provides you with the widest range of quality hand, power tools and woodworking machinery all at the keenest prices.

OVER 10,000 LINES IN STOCK!

We hold massive stocks, meaning that most items are available for despatch the day you order it. Our website shows up to date stock availability, so you can order with confidence.

FREE DELIVERY

Delivery to UK mainland addresses is free for most orders over £99 and for orders under £99 is only £5.95. See the carriage rates on our website for full details.



1 HR DELIVERY WINDOW

We use DPD Predict for the majority of our deliveries (except heavy or oversize items) so you will receive a 1 hour delivery window via email or text meaning you don't need to wait in all day.

SHOP ON-LINE 24HRS A DAY

Visit our easy-to-use website to see what we mean about range and value. Browse and buy with confidence 24hrs a day from the biggest brands in the business, all at prices you'll find hard to beat.

Here you will find all our **latest offers and deals**.

Why not **subscribe to our regular emails** to keep up with our latest deals and offers or join our **D&M Loyalty Scheme** and earn valuable loyalty points every time you shop.

More details on our website: www.dm-tools.co.uk



MAKE A DATE IN YOUR DIARY...

MASSIVE CHOICE FROM THE BIGGEST BRANDS!



THE UK's No.1 BRANDED HAND, POWER TOOLS & MACHINERY EVENT



KEMPTON PARK RACECOURSE
7th-9th OCTOBER 2016

VISIT OUR EXTENSIVE TWICKENHAM SUPERSTORE
73-81 HEATH ROAD • TWICKENHAM • TW1 4AW
020 8892 3813 • SALES@DM-TOOLS.CO.UK



020 8892 3813
MON-SAT 8.30am-5.30pm
(CLOSED BANK HOLIDAYS)



FREE CATALOGUE
- OVER 650 COLOUR PAGES



VISIT OUR EXTENSIVE TWICKENHAM SUPERSTORE

OUR CUSTOMERS LOVE US!

We are regularly receiving 5 star reviews on the independent review site Trustpilot, as well as testimonials direct from our customers, here are just a few:

★★★★★

"D&M tools are very well priced, turn up on time and have superb telephone support just in case anything goes wrong. This is a business I will use in the years to come. Thanks for a job well done."

★★★★★

"Quick Quality Quantity and Value - D&M offer a fast efficient service which they couple with an excellent range of manufacturers tools which are always available in the numbers you need at a competitive price."

★★★★★

"Best customer service... Ever! - I believe the real test of a companies customer service is when they have to deal with problems. My delivery came quickly and well packaged. I had an issue with the tool after about a month of use. The guys in the phone quickly arranged for collection, repair of the tool and return with great communication throughout. Very pleased with the way they resolved my issue."

★★★★★

"Brilliant prices and brilliant service - I have now traded with D&M Tools twice now and both times have received impeccable service and also nothing is to much trouble for their staff to sort out."

★★★★★

"Excellent service makes a refreshing change - first time I have used this company, was quite amazed by the quality and speed of service and delivery, a fine example of what can be done with first class staff."

★★★★★

"Best place for tools online - I've bought a lot of gear from D&M Tools over the last few years and they always provide a first class service, plus they always seem to have everything I need at the time."

www.trustpilot.co.uk/review/www.dm-tools.co.uk



In brief...

ANY OTHER BUSINESS

In a changing world, the only thing certain is more change, but it's how we deal with it that makes the difference between a smooth transition and a dragged out reluctance. It's probably worse if it's something that's stayed the same for years, but recently things appear to be changing at a faster rate. If things are changing quickly all the time, then it's much easier to adapt and accept a new order. This is no bad thing when it comes to woodworking kit, power tools and similar; we all like innovations and most of the ones offered to us of late have definitely been worth having.

Changes ahead

Here at *The Woodworker* we're planning a change or two; nothing radical but just something of a new look really. While we may not be a cutting-

edge style magazine we want it to look good, but I'd like to think that the vast majority of our readers are more interested in making things than they are about page paper and fonts; so don't worry too much on that front. I do think it's important to make something one can be proud of though, so we welcome your patience while we give things a tweak.

It goes without saying that you the reader are the most important part of the magazine; without you it is nothing. With this in mind I'm going to issue an open invitation to everyone to write in with suggestions for ongoing improvements. These can be anything at all, and each will be taken seriously and given due consideration. Despite our limited budget, if an idea is a good one we will do all we can to make it come about. Roll on the future! **MC**

SAWS WITH BITE

This feature-packed affordable range is made with a rigid, high-quality, 1mm carbon steel blade to ensure precision and straightness of cut.

The Draper Venom™ range has saws to suit a variety of trades and tasks and includes fast cutting double- and triple-ground blade options. Each saw benefits from an optimum tooth design for smooth, effortless cutting.

All saws also feature a lacquered coating to reduce friction and prevent corrosion and an ergonomic comfort grip handle to help reduce fatigue on the job. You'll also find helpful 45° and 90° guides for marking out.

The colour-coded handles also help you choose the right saw for the right job.

For rough cutting of sawn timbers there is a range of First Fix saws. For fine detail cutting jobs, where the quality and precision of the cut really counts, Second Fix saws are available. Tenon saws for smaller jobs also form part of the colour-coded Venom range.

The impressive new Draper Venom range is available now at great prices. For stockist details, visit www.drapertools.com.



NEW MITRE PLANES FROM VERITAS

With the new Veritas mitre plane you have the choice of blade in either



O1 or PM-V11 tool steel. The body is fully stress-relieved, ductile cast-iron, with both sides machined flat and square to the sole. Weighing almost 2.25kg, it has a heft that provides good inertia. Its 266mm long and 68mm wide sole, with a toe fully one-third the length, gives it solid registration even when used at an angle for a skewed cut.

Being a bevel-up plane, it has a low 12° bed angle for exceptionally clean end-grain cuts and offers a comfortable grip whether you use it on its side or upright.

Both the knobs and the shooting horn are made of torrefied maple. By loosening the front knob, the plane's adjustable mouth can be set to a fine opening. A brass thumbscrew retains mouth settings and prevents the toe from contacting the blade.

Prices start from £256.96 for the plane with the O1 blade – see www.brimarc.com. Please note that prices include VAT and are correct at the time of publication but may be subject to change without notice.

DIARY

JUNE

- 9–10** Adirondack chair *
- 13** Pyrography – Ben Beddows
- 16** Woodturning refresher
- 17** Sharpening with Tormek Woodturning *
- 22–23** Beginners' routing *
- 30** Kitchen door/jointing

* Course held in Sittingbourne, Kent

Axminster Tools & Machinery
Unit 10 Weycroft Avenue
Axminster, Devon EX13 5PH
Tel: 08009 751 905

Web: www.axminster.co.uk

- 12–15** An introduction to picture framing
- 17–19** Marquetry techniques
West Dean College
West Dean, near Chichester
West Sussex PO18 0QZ
Tel: 01243 811 301
Web: www.westdean.org.uk

- 11–12** Wood machining
John Lloyd Fine Furniture
Bankside Farm, Ditchling
Common
Burgess Hill, East Sussex
RH15 0SJ
Tel: 01444 480 388
Web: www.johnlloydfinefurniture.co.uk

- 18** Chair making – part I
- 24** Beginners four-day course
Chris Tribe
The Cornmill, Railway Road
Ilkley, West Yorkshire LS29 8HT
Tel: 01943 602 836
Web: www.christribe-furniturecourses.com

- 6** Carpentry for beginners – wood puzzle
- 9** Carpentry for beginners – step-up stool
- 11** Intro to woodwork (2 days)
- 12** Carpentry – build your own project
- 12** Hand caning furniture
- 15** Intro to woodcarving
- 25** Intro to woodwork – shelf & brackets
The Goodlife Centre
122 Webber Street,
London SE1 0QL
Tel: 0207 760 7613
Web: www.thegoodlifecentre.co.uk

UK'S BIGGEST RANGE
15,000 PRODUCTS IN STOCK FOR NEXT DAY DELIVERY

CALL 7am-8pm 7 days a week

0808 168 28 28

ONLINE Shop 24/7!

IronmongeryDirect.com



CALL TODAY
FOR YOUR FREE CATALOGUE



MADE STRONGER. LASTS LONGER.™

25%
STRONGER*

**IRWIN WELDTEC™
CONSTRUCTION BLADE
WITH WELDED
CARBIDE TEETH**

irwin.co.uk *When compared to IRWIN part number 1897209. Tested for durability on the most demanding applications.

IRWIN®
TOOLS



The Rocking Horse Shop

Make a Unique Traditional Rocking Horse, 17 Superb Designs



Plans, books, DVD's, timber packs, accessories & fittings.

Carving Courses

Whether you are an experienced carver or have never carved before, you will benefit enormously from one of our courses.



www.rockinghorse.co.uk

Tel: 0800 7315418

Fangfoss, YORK YO41 5JH



TURNERS TOOL BOX
DAVID MARTIN



CREATIVE WELSH WOODTURNING LTD.

Turners Tool Box.Com

WOODTURNING – WOODWORKING – WOODCARVING
TOOLS & ACCESSORIES

LOG ON TO:

www.turnerstoolbox.com



Woodturning Chucks including the:
Robert Sorby Patriot Woodturning Chuck
Axminster Evolution SK114 Woodturning Chuck
All with additional accessories making your time at the lathe a more pleasurable experience



New
Pen Mandrel Support



New

Bolt Action & Bullet Pen Kits
In a variety of different metal finish's
Including the required sized
Drill bits & the bushing sets



Colt MaxiCut® Forstner Bits:
Metric & Imperial Sizes

Extension Bars &
Morse Taper Adaptor



Colt HSS-M2 150mm Pen Drill Bits
Sizes from 7mm upwards



DELIVERED WORLD WIDE

For more information Visit: www.turnerstoolbox.com
Order online Open 24hrs – All at the click of a button and delivered straight to your door
Email: info@turnerstoolbox.com – Tel: 01873 831 589 – Mobile: 07931 405 131



In brief...

THE WOODWORKER TIMBER SUPPLIERS DIRECTORY, JUNE 2016

Adhectic Ltd

Tel: 01235 520 738
Web: www.adhectic.co.uk
(Abingdon)

A Harrison

Tel: 01536 725 192
Web: www.aharrisonwoodturning.co.uk
(Northants)

Bennetts Timber

Tel: 01472 350 151
Web: www.bennettstimber.co.uk
(Lincolnshire)

Black Isle Woodturning

Tel: 07842 189 743
Web: www.blackislewoodturning.com
(Scotland)

Brodies Timber

Tel: 01350 727 723
Web: www.brodiestimber.co.uk
(Perthshire)

Brooks Brothers Timber

Tel: 01621 877 400
Web: www.brookstimber.co.uk
(Essex)

C&G Barrett Ltd, Cilfegan Sawmill

Tel: 01291 672 805
Web: www.cilfegansawmill.com
(Monmouthshire, South Wales)

D Emmerson Timber

Tel: 01507 524 728
Web: www.emmersonstimber.co.uk
(Lincolnshire)

Earlwood Interiors

Tel: 01564 703 706
Web: www.earlwoodinteriors.co.uk
(Solihull)

English Woodlands Timber

Tel: 01730 816 941
Web: www.englishwoodlandstimber.co.uk
(West Sussex)

Exotic Hardwoods

Tel: 01732 355 626
Web: www.exotichardwoods.co.uk
(Kent)

EO Burton, Thorndon Sawmills

Tel: 01277 260 810
Web: www.eoburton.com
(Essex)

Eynsham Park Sawmill

Tel: 01993 881 391
Web: www.eynshamparksawmill.co.uk
(Oxfordshire)

FH Ives

Tel: 01268 732 373
Web: www.fhives.com
(Essex)

Fulham Timber

Tel: 0208 685 5340
Web: www.fulhamtimber.co.uk
(London)

G&S Specialist Timber

Tel: 01768 891 445
Web: www.toolsandtimber.co.uk
(Cumbria)

Good Timber

Tel: 01327 344 550
Web: www.goodtimber.com
(Northamptonshire)

Interesting Timbers

Tel: 01761 241 333
Web: www.interestingtimbers.co.uk
(Emborough)

ISCA Woodcrafts

Tel: 01633 810 148/07854 349 045
Web: www.iscawoodcrafts.co.uk
(Newport, South Wales)

John Davis Woodturning Centre

Tel: 01264 811 070
Web: www.johndaviswoodturning.com
(Hampshire)

Joyce Timber

Tel: 0208 883 1610
Web: www.joycetimber.co.uk
(London)

Lincolnshire Woodcraft

Tel: 01780 757 825
Web: www.lincolnshirewoodcraft.co.uk
(Stamford)

Nottage Timber

Tel: 01656 745 959
Web: www.nottagetimber.co.uk
(Bridgend, South Wales)

Ockenden Timber

Tel: 01588 620 884
Web: www.ockenden-timber.co.uk
(Powys)

Olivers Woodturning

Tel: 01622 370 280
Web: www.oliverswoodturning.co.uk
(Kent)

Oxford Wood Recycling

Tel: 01235 861 228
Web: www.owr.org.uk
(Oxfordshire)

Stiles & Bates

Tel: 01304 366 360
Web: www.stilesandbates.co.uk
(Kent)

Scadding Timber

Tel: 01179 556 032
Web: www.scadding-son-ltd.co.uk
(Bristol)

St. Andrews Timber & Building Supplies

Tel: 01316 611 333
Web: www.standrewstimbersupplies.co.uk
(Scotland)

Surrey Timbers Ltd

Tel: 01483 457 826
Web: www.surreytimbers.co.uk
(Guildford)

Sykes Timber

Tel: 01827 718 951
Web: www.sykestimber.co.uk
(Warwickshire)

The Timber Mill

Tel: 07966 396 419
Web: www.thetimbermill.com
(Cornwall)

The Wood Recycling Store

Tel: 01273 570 500
Web: www.woodrecycling.org.uk
(East Sussex)

Thorogood Timber Ltd

Tel: 01206 233 100
Web: www.thorogood.co.uk
(Essex)

Timberman

Tel: 01267 232 621
Web: www.timberman.co.uk
(Carmarthenshire)

Waterloo Timber Ltd

Tel: 01200 423 263
Web: No website
(Lancs)

Wenban Smith

Tel: 01903 230 311
Web: www.wenbans.com
(Worthing)

W L West & Sons Ltd

Tel: 01798 861 611
Web: www.wlwest.co.uk
(Surrey)

Yandle & Sons Ltd

Tel: 01935 822 207
Web: www.yandles.co.uk
(Somerset)

**UK'S BIGGEST
SUPPLIER
OF IRONMONGERY
TO THE TRADE**

**ORDER BY 8PM
GET IT NEXT DAY!**

CALL 7am-8pm 7 days a week
0808 168 28 28

ONLINE Shop 24/7!
IronmongeryDirect.com



**CALL
TODAY
FOR YOUR FREE
CATALOGUE**

ADD A NEW DIMENSION TO YOUR WORK WITH

Visit our Online Store Today!
(web address at bottom of this advert)

metalcraft™

Easy to use tools that do not require heat or power



Ideal wherever wood and steel can combine to make stylish...

- Furniture
- Clocks
- Signs
- Frames & Decorative Panels
- and so much more

Call today for our free Catalogue and if you quote the promo code "MTW16" we will send you our new demo DVD free of charge

J & C R Wood Ltd, Dept MTW16, 66 Clough Road, HULL HU5 1SR
01482 345067 | info@jandcrwood.co.uk

www.metal-craft.co.uk

the WoodRat® is not just here for the dovetailing



WoodRat's Mortise Rail MR4 clocks in the length and position of any number of mortises. Each pair exactly placed on opposing stiles – simple, accurate and very quick!

see it in action - www.woodrat.com

Protect and enhance the natural beauty of wood with Treatex Hardwax Oil



Table designed and built by Jim Sharples Furniture



treatex®
Naturally superior wood finishes

Treatex Hardwax Oil

protects and enhances the appearance of all types of internal wood surfaces including floors, stairs, doors, furniture and worktops. Treatex Hardwax Oil is manufactured on a base of natural sustainable raw materials: jojoba oil, linseed oil, sunflower oil, beeswax, candelilla wax and carnauba wax.

- Brings out the timber grain
- Adds warmth to wood
- Easy to apply
- Quick drying
- No sanding required between coats
- Low odour
- Resistant to spills of water, wine, beer, coffee, tea and fizzy drinks
- Withstands high temperatures
- Very durable
- Easy to clean and maintain
- Spot repairable
- Safe for use on children's toys

tel: 01844 260416
www.treatex.co.uk

What's new from

'THE' TOOL SPECIALISTS • WWW.DM-TOOLS.CO.UK • 0208 892



DWE6423 RANDOM ORBIT SANDER

MANUFACTURER: DeWALT
D&M GUIDE PRICE: £109.95

The new DWE6423 random orbit sander from DeWALT features a 280W motor that spins the pad at 8,000-12,000opm. The shorter height allows the user to get closer to the workpiece for sanding and the rubber over-mould in all of the critical areas makes it easy to grip and manipulate. A separate counterweight design reduces vibration for improved comfort and an improved dust-sealed switch protects against dust ingestion for longer switch life. The machine also features improved dust collection and interfacing with the DeWALT vacuum locking system. The dust bag also has a one-hand locking system. The dust port is designed to fit directly to DWV010 or DWV012 dust collectors and to attach the dust port to other vacs with 32mm hoses, use the DWV9000 universal quick connector. The sander is available in both 240V and 110V versions.



DWS777 XPS 216MM SLIDING MITRE SAW

XPS
CROSS CUT POSITIONING SYSTEM

NEW



MANUFACTURER: DeWALT
D&M GUIDE PRICE: £339.95

This new sliding mitre saw from DeWALT features a 1,800W motor for powerful cutting in all materials (1,600W, 110V) and features the XPS shadow line cut indicator, which provides fast, accurate alignment. Improved dust extraction is specifically designed to meet the needs of the professional user in heavy-duty applications and both the base and fence are machined to meet the accuracy requirements of the most demanding applications.

A new head lock function allows the head to be fixed, restricting the traverse function for trim applications and ease of transportation, plus integrated positive mitre stops at 15, 22.5 and 30°, as well as a 45° quick-release mitre mechanism up to 50°. It has a sliding left-hand fence with measuring scale for improved material support and management and the compact internal rail design allows for huge cutting capacity in a highly transportable format. Available in both 110V and 240V versions.

CONNELL WOODWORKING RANGE OF LEATHER PRODUCTS

MANUFACTURER: Connell of Sheffield
D&M GUIDE PRICE: From £8.99-£84.99

D&M Tools has recently added a new range of Connell of Sheffield leather products to their range of tool rolls and pouches. If you value your tools and want to protect them for years to come, you will want to invest in these. Connell are proud to support British industry by purchasing their leather and suede from British tanneries who are acknowledged experts in their field.

The Connell range of products is made from high-quality chocolate brown soft or moss-backed leather and are stitched in rot-resistant nylon bonded thread for extra durability. Connell are also very proud to be able to display the 'Made in Sheffield' mark.

On the right you can see a selection of the products available, which include plane and spokeshave wallets, saw cases, chisel and knife rolls as well as a tool bag, apron and belt. For more products and details, see the website – www.dm-tools.co.uk.



PLEASE CHECK OUR WEBSITE – WWW.DM-TOOLS.CO.UK – FOR THE LATEST PRICES AND DEALS

A chair fit for a king

Andy King picks up his tools and shows us how to make his popular pallet chair

Having demoed at my friend Angus Bell's trade days over the last few years, the brief has always been to 'demo the tools and make a few things', which normally resulted in me knocking up a few bits and pieces, usually for use in the shop.

A couple of years back, I had ran out of timber for my normal demoing and was too busy to go to the timber yard for more, so racking my brains and spotting a pile of pallets, I knocked a few apart and off the top of my head set about making a chair.

It was nothing elaborate, simply butt joints and screws, but effective enough to have the customers all commenting on how they liked it, as well as having all the reps from the power tool suppliers, who were also demoing, fighting each other over who would have it! I ended up making a fair few over the course of the two days.

Timber choices

So having been asked by Makita if I could demo some of their products at last year's D&M Tool Show, building a suitable project along the way, it made sense that I did similar.

This time around I opted for some better quality timber and went to one of the sheds for a few shrink-wrapped packs of planed timber. To be honest, on opening the packs, the timber was little better than the pallets!

I did manage to get a few chairs knocked up at the show, and they were as popular as before. As fast as I finished one, it was gone – and in between, loads of customers were asking if they were for sale, where they could get plans, and if it would appear as a project in the magazine, so here we are!

Here I'll do my best to extract the 'plans' in my head and get them down on paper for anyone who likes the look of the chair and fancies making one, either by recycling pallets or using a better quality timber.

Either way, as these are likely to be used outside, you will need to apply a timber preservative, such as Cuprinol, as well as a top coat finish, and again, Cuprinol has a great range of different colours.

For this project I've gone back to the sheds for my timber, but this time I've opted for some redwood. Despite the bad press

the sheds get for their timber, and rightly so in the case of the whitewood packs, if you go to the B&Q Trade Centre stores they normally have a decent range of redwood sections and at a good price.

As with any timber, sort through what's there and pick the best. Don't be put off if there are some bent, split or other flawed



1 Mark the curvature of the seat onto the rod using a thin, flexible lath

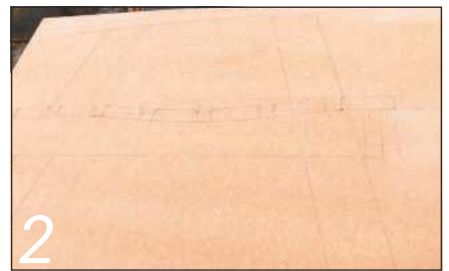

2 The completed side elevation now has all the correct positions to mark out from



3 Cut the seat slats, front and rear seat frame components at 450mm long



4 The rod is now used to transfer length and layout positions for the sides of the seat frame



5 Dropping the components back onto the rod transfers the additional information



6 The lath is used to transfer the curvature of the seat to the frame component



7 This is then cut with a jigsaw and used as a template for the opposite piece



8 Using a roundover bit, the slats are routed to ease the top edges



9 The pieces can be dropped onto the rod to check for accuracy or to transfer further marks



CUTTING LIST

Note that all timber is 75 x 25 ex PSE

Seat slats:	7off	@ 450mm
Seat frame:	2off	@ 450mm
	2off	@ 540mm
Legs:	4off	@ 650mm
Leg rails:	2off	@ 650mm
	1off	@ 490mm
	1off	@ 450mm
Back slats:	5off	@ 800mm
Back stiffener:	1off	@ 600mm
Arm rests:	2off	@ 500mm

pieces, as you can normally get the trade counter staff to knock a bit off. As this project uses lengths of around 450-900mm long, if you do have to get a few flawed pieces you can easily cut around them.

You don't have to use shed timber of course, but this project is designed for anyone to make using basic tools so the option of easily accessible timber fits well.

So with that in mind, simplicity is the order of the day, and sticking with one timber size makes life all the more easy, and therefore a 70 x 20mm PAR stock size is all that is needed, but again, you can alter to suit your own needs and adapt.

When I make these in a 'live' situation, it's all a bit 'make it up as you go along', but still built around the same core of a slatted box seat, legs that extend to support arm rests and a slatted back, normally with a fan shape for extra support. It's all about introducing a curve or two for comfort, and the first step is to make a rod for the basics. When demoing it's a lot of checking with tapes, offering up, checking again, etc. but a rod makes life so much easier!

The rod

On a major project, different rods showing front and side sectional elevations and also a plan view is normally the minimum, but here, you only need a side elevation to set out the curve of the seat as well as the splay of the legs and angle of the seat.

There's no hard and fast rule in angles or splays, but I tend to work on tilting the chair seat by about 40 or 50mm from parallel to the floor; this makes it more comfortable to sit on as you naturally lean back in the chair as you sit on it.

The more important dimensions are the height of the seat itself as well as the width between the arms. The height of a chair is normally around 400-450mm high to the seat, so that's the basic starting point for the rod. You also need to work out the depth of the seat from front to back; this is simply a matter of setting out the slats and with 70mm-wide stock, I tend to go for six or seven slats with each one spaced by the thickness of the stock, so 20mm. This gives an overall length for the seat, so you can begin marking up the rod.

Make a mark at 450mm from the edge of your rod board – a sheet of MDF is ideal. Taking the front to back measurement as determined by the initial stepping out of the slats, a second mark is made, this time at 400mm; this sets the slope for the seat base frame.

Using the timber as a gauge, mark in a set of parallel lines to indicate the seat. Next, mark in the curvature of the seat. I allow the front slat and the back two slats to sit square to the seat frame. The curve of the seat is set between these two points with a 15mm deep curvature. If you don't have the luxury of a second pair of hands for marking the curves, a couple of screws or pins at the springing points will allow a thin lath to be pushed in to mark the curve (**photo 1**). You can now draw the slats in, with the front slat projecting by 20mm as a nosing, but it can be kept flush if you wish. You can then draw in the leg splays. I tend to go for a splay that sets the legs around 50mm beyond the front and back of the seat for stability and around 15° pitch. Mark these in, extending them up beyond the seat



10 The seat frame is screwed together using stainless steel fixings for durability



11 The seat frame is positioned on the rod to transfer the leg splay positions



12 The marks are connected to ensure the legs are positioned accurately when fixed



13 Screw the slats into place using 60 x 5mm stainless screws



14 Use a slat as a spacer to position the remainder of the slats and fix in place



15 Lay the legs onto the rod...



16 ... and transfer the marks



17 Cut to length on the mitre saw. A laser comes in handy here for accurate working



18 Align each leg to the layout marks and screw in place

line to act as supports for the arm rests. The arm rests are drawn in parallel to the seat; I find around 200mm above is about right. So that is the basic side elevation drawn in (photo 2), which is all that is needed to make the chair; the rest is constructed once the basic seat and legs are built.

Construction

From here on in you can reference from the rod for the majority of the pieces you need to cut; the only measurement to determine is the width of the chair. This needs to be wide enough to sit in comfortably without feeling squeezed in. I settled on 450mm wide, which allows plenty of room to get in and out. You can now start cutting up materials ready to start the project.

The frame that the slats are fixed to has front and rear components that are equal to the slat lengths, so cut nine pieces at 450mm for these two components and the seven seat slats (photo 3).

The side components of the frame are cut by placing the stock onto the rod and transferring the marks directly and cutting

to length (photo 4). The sides now need to have the curve cut into them for the slatted seat. Drop the side piece onto the rod and mark the springing points (photo 5). Run long screws into the springing points of the rod, which allows you to place one component directly to the rod and bend the lath to the correct position and mark the curve (photo 6). This is cut with a jigsaw and then used as a template to mark up the opposing piece to give a left and right component (photo 7).

Seven of the slats are routed all round with a roundover on the top edges (photo 8), with one of them having a further roundover on the underside of one long edge, which becomes the bull-nosed front slat.

Next, screw the seat base together. Check the curve is correct by placing it back on the rod before assembly (photo 9).

The fixings for the chair need to be durable and having been recently sent a few samples of the latest Concept KTX fixings, including some stainless steel ones, these are perfect for the job. The four frame components are piloted and screwed using

60 x 5mm stainless screws (photo 10). The frame is then placed back onto the rod and the leg positions transferred to the frame (photo 11).

Connect the marks (photo 12) and then fix the slats in position using the same screws (photo 13), spacing them out using one slat or an offcut as the spacer (photo 14), or, if you prefer, you can transfer the positions from the rod.

Legs & slats

Next, mark up the legs from the rod by dropping one front and one back leg directly to the rod and transferring the overall length marks and also including the positions where each leg sits against the seat frame (photos 15 & 16). Use each leg as a template to mark up its matching component before cutting to length on the mitre saw (photo 17). This is where the power of the rod increases its value: no need for tape measures, sliding bevels or protractors; the angles set themselves directly from the marks and if you have a laser on your mitre saw, all the easier to set



19 Check the chair sits flat and the legs are correctly in contact with the floor



20 Side rails are spaced and positioned directly to the legs and marked for cutting



21 You can then screw the rails in position to the inside of the legs



22 Before fitting the front rail, round over the edges of the legs



23 Mark the front rail to length and you're then ready to cut to size



24 You can then round over the edges and screw into place



25 Next, cut the back leg rail to the inside width of the legs



26 Use the lath to mark a concave curve on the back seat slat



27 Remove the slat and cut to shape

for the cut. If you don't have a mitre saw, it's quick enough to cut to length with a tenon saw or similar.

The legs are screwed to the seat frame using 35 x 5mm screws, aligning each leg using the marks taken from the rod (**photo 18**). Check the chair sits flat with the legs fitted (**photo 19**) and the main part of the construction is now complete using the rod to gain your marks and sizes.

The legs now need rails to stiffen them up and prevent them from splaying. No hard and fast rule here; I simply spaced the rail by using a couple of pieces of stock as a gauge to set it parallel to the seat before striking marks directly to each leg and cutting to size (**photo 20**). These are screwed into position using 35 x 5mm screws, the side rails fitting to the inside of the legs (**photo 21**).

Round over the legs on the external long edges; this can be done prior to fixing the legs, but it's easy enough with the legs in place (**photo 22**). A front rail is marked from the assembled lower chair (**photo 23**), cut to length and routed to round over the edges.

Screw the front rail in place (**photo 24**) and that's the main part of the job done where the rod and lower frame is concerned; from here it's more a case of winging it and eyeballing in the back slats and curvature.

First off, cut a lower rail to fit between the legs (**photo 25**). The last slat on the seat is marked up with a curve to give the back a more comfortable feel when you lean back into it. The depth of the curve isn't huge; I set a mark 15mm back from the edge at the centre position of the slat and marked a curve using the lath (**photo 26**). This is jigsawed out (**photo 27**) and is then used to transfer an opposite curve (**photo 28**) to a second piece that is then jigsawed to become the shaped lower back rail (**photo 29**). The idea here is for the top slat to sit behind the back slats to support them while the lower one sits in front of the slats, so that any pressure from leaning hard on the back is transferred through the rails and won't rip any fixings out.

Fixing the top seat slat into position with a mark to show the centre, the middle back slat is dropped through. The length of the

slat isn't important just yet; I cut it around 900mm long. The lower back rail is placed onto the side rails and with the back slat in place, lean it back until it looks like it is inclining back enough to provide sufficient support without feeling like you are sitting bolt upright (**photo 30**).

Remember that the seat is already tipped back so the slats can actually sit at 90° to this and still be leaning back. This is where it's more a job by eye than a specific angle and you can easily alter it if you feel it is too far back or not enough. Once the position looks good, make a mark where the lower rail will sit ready to screw it in place. If you have a right angle drill or attachment, the rail can be fixed using this (**photo 31**), but you will find it easier to remove a couple of seat slats for better access. You'll need to remove a couple of them to fix the back slats anyway, so it's the easiest solution here.

Fix the centre slat with a screw to the lower back rail (**photo 32**) and do the same into the upper seat slat (**photo 33**). Using an offcut as a spacer, the outer slats can now be positioned (**photo 34**). The outer



28 The slat is used to transfer the curve to the lower back rail



29 Cut the lower back rail to give a convex shape

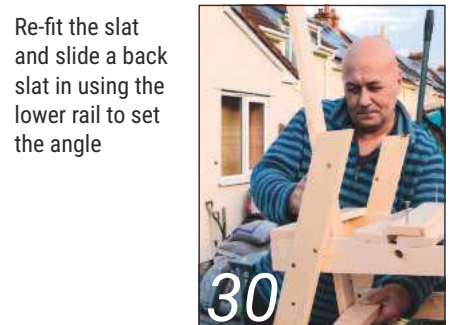

Re-fit the slat and slide a back slat in using the lower rail to set the angle



31 Once you are happy with the position, fix the lower back rail into place



32 Fix the centre back slat to the lower rail with a 60 x 5mm stainless screw



33 Fix the slat centrally to the seat back with the same sized screw



34 Use an offcut as a spacer to set the outer back rails



35 Set the intermediate slats central to the others and fix in place



36 Mark out the curve on the back using a suitable lath

slats of the fan back are determined by trapping the lower position of the slat against the spacer with the slat fanned out and pushed tightly against the side of the seat frame (**photo 34**).

Strike a mark on the lower position and cut it to make it flush with the underside of the lower rail and repeat for the other slat, fixing in the same manner as the centre slat.

The intermediate slats are now positioned by simply halving the remaining space on the seat slat to gain the centre position, dropping the back slats into place and marking the lower position to bring it flush with the rail and cut and screw both into position (**photo 35**). Although, in theory, the lower curvature on the leg rail should be different from the seat slat curve as the slats taper in like a wedge, the shallowness of this curve is not sufficient enough to worry about trying to work out the geometry. Likewise, the fit between the back slats and the curved rails, if cut at 90°, will have a slightly open joint with the slats leaning back slightly. You can cut these curves with a slight bevel or spokeshave

them, but again it's a minimal difference and not enough to concern you.

The rounded top of the fan back is cut by determining how much of a curve you desire. I made the centre slat 800mm long overall and the outer ones 700mm, linking the positions with a flexible lath (**photo 36**) and cutting the marks with a jigsaw (**photo 37**). I rounded the back slats over with them fixed in position. This could be done by removing each one and re-fitting them but I like the look of the stopped position where the cutter bottoms out as the taper between the slats narrows and stops the cut.

Final components

The final three components are the two armrests and a further stiffener for the back slats. The back stiffener is marked up by temporarily screwing a piece of stock through the centre slat that spans the width of the fan back. Using a gauge block, the positions of the other slats are marked onto the stiffener (**photo 38**) before removing it and cutting with a jigsaw. Once done, check the fit against

the slats (**photo 39**) before radiusing the outer corners and rounding over the edges with a router (**photo 40**) before fixing through each slat.

The armrests are secured to the legs and also through into the outer back slats. Keeping the inside of the rests flush to the legs ensures the seat retains its full width when sitting down.

Mark the notch to fit over the back slat on each piece (**photo 41**); this will need a second bit of scribe work to bring the fit up. This particular area is on show so it is worth the extra work here. Once the fit is good, the armrest can be shaped (**photo 43**). Secure the arms into the legs and also through the outer back slat. And that's it, the chair is complete (**photo 44**) – from here it's just a matter of finishing the chair to your own requirements. Looked after and given a coat of protection each year, the chair should last for a fair few years and hopefully we will have the type of summer where you can get out in the garden with a cool drink and relax on your new piece of furniture! **WW**



37
Cut the slats to length with a jigsaw and clean up as necessary



38
Using a gauge block, the back is scribed and cut with a jigsaw



39
Check the fit of the stiffener against the slats



40
Radius the ends and round over the edges of the stiffener



41
Screw back through the slats to secure the stiffener



42
The initial cut will need scribing to allow for the angle of the back slat



43
Once scribed, you should be left with a neat fit, as shown here



44
Once the edges have been radiused and rounded over prior to securing, it's job done!

In your own write...

Here are just some of the latest letters we've received since the last issue. Drop us a line on paper or via screen and keyboard to add your voice to the woodworking crowd; you might be one of the lucky few who will manage to get their hands on a coveted *Woodworker* badge!

The Woodworker
& Woodturner

SNAIL MAIL OR EMAIL?

You can write to us at *The Woodworker*, MyTimeMedia Ltd, Enterprise House, Enterprise Way, Edenbridge, Kent TN8 6HF or send an email to mark.cass@mytimemedia.com

TIMBER IN NEW ZEALAND

Dear Mark,

At the beginning of the year my wife and I visited our son and family in New Zealand. While there, we had occasion to visit Lyttelton Harbour. This is where four ships sailed in carrying the early settlers.

Today, it is an important hub for the export of New Zealand timber – see attached photo that my grandson took for me. I have never seen so much timber.

Although New Zealand is a small player in the international forestry industry, wood products are New Zealand's third largest export earner. The plantation forests cover about 7% of the country's land area. Radiata pine is 90% of the plantation area, Douglas fir about 6% and the rest is made up of eucalyptus and other species.

There is some controversy with New Zealand's woodworkers and woodturners because, as well as the above, they are exporting native 'swamp kauri'. Kauri trees were bowled over at the end of the last ice age and buried in peat swamps where they have been perfectly preserved. Kauri timber is a light honey colour, with a distinctive silvery speckled lustre. It is ideal for turning and carving and the 'locals' want to hang on to it!

Perhaps as an Editor's perk you could have a trip down to New Zealand to write an article about the kauri timber! Best regards, **Norman Gilbert**



Softwood fills this timber carrying vessel at anchor in the picturesque harbour at Lyttelton near Christchurch, New Zealand

Hi Norman,

Thanks for the photo – that sure is a heck of a lot of timber. Very interesting about the Kauri stocks; it's a bit like our bog oak over here, something that's never going to be anything but a finite resource. I expect there'll be the usual battle between conservation and commerce – I wish good luck to the Kiwi woodworkers.

And yes, the thought of a trip to NZ is a very tempting one, but it's a sad fact that Editors' perks have been greatly reduced over the last few years and are now almost non-existent...

Mark

CHILD-SIZE BOW WINDSOR CHAIR

Hi Mark,

Many thanks for the email (forwarded from Tom Greaves, another reader and turner).

I have already seen the piece on the smoker's bow Windsor chair by Colwin Way as I joined the local woodturning club, and one of the members gave me the article. I have scaled down the measurements to make a child's version, but have modified parts of it. I have turned the legs and stretchers and have carved out the seat in oak. The next stage is to steam a piece of ash to form the back and arm rests, but I need to find or make a steam box for this step. I have been keeping a photo record

of my progress, which might form the basis of a future article! I look forward to the next edition of *The Woodworker*. With all good wishes, **Duncan Hepburn**

Hi Duncan,

Well that's looking really good, and it seems to me that you shouldn't find the next couple of stages too difficult at all. As long as you mark it all out accurately and bore the holes for the back sticks at the correct angle, you're in with a good chance.

What's really on your side is the amount of 'give' that's inherent in this type of chair and, even if you're a bit out, you can usually persuade things to fit – eventually! Some people just screw through the arms into the

support below, but if you can dowel them or even Domino it'll be much neater. Just take your time and use as many thin ply or even cardboard templates as is necessary.

And the final comfort: as least you'll know how you should do it next time! **Mark**



A scaled-down work in progress

GET IN TOUCH!

Don't forget, we're always keen to see your photos, so please don't hesitate to send them in if you've snapped something of interest recently. Email me at the usual address: mark.cass@mytimemedia.com

schepach

← 1100 W

60 mm

200 mm

WORKSHOP



PROMO PACKAGE

INCLUSIVE
TABLE WIDTH EXTENSION & BASE UNIT

INCLUSIVE
SLIDING TABLE CARRIAGE



+



+

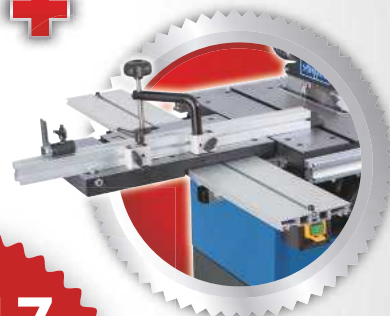

CAST IRON TABLE

£524.17
EX VAT
£629.00
INC VAT

CARRIAGE PAID UK MAINLAND ONLY

2 year Guarantee

PRECISA TS82 | 8" TABLE SAW WITH SLIDING TABLE CARRIAGE, TABLE WIDTH EXTENSION & BASE UNIT

THE NEW SCHEPPACH PRECISA TS82 CIRCULAR SAWBENCH IS THE PERFECT SOLUTION FOR THE SMALL WORKSHOP. IDEAL FOR THE DISCERNING HOME WORKSHOP USER AND LIGHT PROFESSIONAL USE.

- Sliding table carriage standard
- Powerful 1100 Watt induction motor
- Long life TCT blade – Ø 200 mm
- Sturdy, powder-coated sheet steel design and cast iron table-top
- Table width extension
- Blade guard with suction hose outlet
- Fully adjustable blade height by easy use of handwheel
- Sturdy parallel guide / ripping fence and mitre gauge

SPECIFICATIONS	
Dimensions L x W x H	1430 x 1000 x 1060 mm
Saw blade Ø	200 mm
Table size	530 x 400 mm
Table size with extension	530 X 1000 mm
Table height	870 mm
Cutting depth at 90° max.	60 mm
Cutting depth at 45° max.	44 mm
Motor	230 V~
Input	1100 W

Issue 2016-03-02 | Changes reserved

NMA
AGENCIES LTD

We have now moved to our new address :

Unit 1, Brookfoot Business Park
Brighouse, West Yorkshire
HD6 2SD

www.nmatools.co.uk
Tel: (01484) 400 488
Email: sales@nmauk.com

Machine Mart

NOW 65 SUPERSTORES NATIONWIDE

WHERE QUALITY COSTS LESS

Clarke TABLE SAWS

FROM ONLY £69.98 EX.VAT
£83.98 INC.VAT

LEG STAND KITS FOR CTS100 AND CTS111 ONLY £27.59 INC.VAT*

INCLUDES LEFT & RIGHT TABLE EXTENSION

CTS100

MODEL	MOTOR	BLADE	EXC.VAT	INC.VAT
CTS800B	600W	200mm	£59.98	£83.98
CTS11	1500W	254mm	£139.98	£167.98
CTS100	1500W	254mm	£159.98	£191.98

Clarke 4" BELT/ 6" DISC SANDER

- Dust extraction facility
- 4" x 36" belt tilts & locks 0-90°
- 225mm x 160mm table, tilts 0-90°
- 370W, 230V motor

CS4-6D

£84.98 EX.VAT
£101.99 INC.VAT

Clarke TABLE SAW WITH EXTENSION TABLES (250mm) CTS14

Ideal for cross cutting, ripping, angle and mitre cutting • Easy release/locking mechanism for table extensions • 0-45° tilting blade • Cutting depth: 72mm at 90° / 65mm at 45°

SHOWN WITH OPTIONAL LEG KIT CLK5 £19.98 EX.VAT £23.98 INC.VAT

£119.98 EX.VAT
£143.98 INC.VAT

Clarke RANDOM ORBITAL SANDER

£29.98 EX.VAT
£35.98 INC.VAT

- For sanding & polishing
- 125mm diameter sanding discs
- 4000-11000 opm

CROS1
INC 5 DISCS

Clarke WOODWORKING VICES

STANLEY

Record

FROM ONLY £13.98 EX.VAT
£16.19 INC.VAT

WV7

MODEL	MOUNTING	JAW (WIDTH/OPENING /DEPT)mm	EXC.VAT	INC.VAT
Clarke	Bolted	150/152/61	£13.49	£16.19
CHT152				
Stanley	Clamped	72/60/40	£16.99	£20.39
Multi Angle				
Record V75B	Clamped	75/50/32	£19.98	£23.98
Clarke WV7	Bolted	180/205/78	£24.99	£29.99

airmaster TURBO AIR COMPRESSORS

tiger

FROM ONLY £79.98 EX.VAT
£95.98 INC.VAT

8/250 Superb range ideal for DIY, hobby & semi-professional use

HUGE RANGE OF AIR TOOLS IN STOCK

* V-Twin

MODEL	MOTOR	CFM	TANK	EXC.VAT	INC.VAT
8/250	2HP	7.5	24ltr	£79.98	£95.98
7/250	2HP	7	24ltr	£89.98	£107.98
11/250	2.5HP	9.5	24ltr	£109.98	£131.98
8/510	2HP	7.5	50ltr	£119.98	£143.98
11/510	2.5HP	9.5	50ltr	£139.98	£167.98
16/510	3HP	14.5	50ltr	£209.00	£250.80
16/1010	3HP	14.5	100ltr	£259.98	£311.98

Clarke 6" BELT/ 9" DISC SANDER

- Includes stand
- 1 HP/ 230V/ 1ph motor

CS6-9C

£209.98 EX.VAT
£250.98 INC.VAT

Clarke DUST EXTRACTOR/ CHIP COLLECTORS

FROM ONLY £129.98 EX.VAT
£155.98 INC.VAT

METABO ALSO AVAILABLE

- Powerful 750W motor
- 56 litre bag capacity
- Flow rate of 850M³/h

MODEL	MOTOR	FLOW RATE	BAG CAP.	EXC.VAT	INC.VAT
CDE35B	750W	450 M ³ /h	56Ltrs	£129.98	£155.98
CDE7B	750W	850 M ³ /h	114Ltrs	£149.98	£179.98

Clarke ELECTRIC POWER FILE

- Variable belt speed
- Tilting head

*Black & Decker **CPF13**

MODEL	MOTOR	EXC.VAT	INC.VAT
CPF13	400W/230V	£44.99	£53.99
KA900E*	350W/230V	£59.98	£71.98

Clarke CORDLESS DRILL/ DRIVERS

BOSCH

Clarke CONTRACTOR

CON18Li

FROM ONLY £36.98 EX.VAT
£44.98 INC.VAT

Clarke ROTARY TOOL KIT

CRT40

£29.98 EX.VAT
£35.98 INC.VAT

- Height adjustable stand with clamp
- 1m flexible drive
- 40x accessories/consumables

Clarke 1" BELT/ 5" DISC SANDER

- Includes 2 tables that tilt & lock

CBS1-5

£64.98 EX.VAT
£77.98 INC.VAT

Clarke POWER PLANERS

BLACK & DECKER

£28.79 INC.VAT

- 82mm cutting width

CEP1

MODEL	MOTOR	DEPTH OF CUT	EXC.VAT	INC.VAT
Clarke CEP1	650W	2mm	£23.99	£28.79
Einhell RT-PL82	850W	3mm	£49.98	£59.98
B&D KW750K - GB	750W	2mm	£57.99	£69.99

Clarke DRILL BIT SHARPENER

CBS16

- Great for 3mm to 10mm HSS drill bits
- 70W motor • Drill bit guide ensures sharpening at the correct angle • Saves cost of new drills

PRICE CUT
£19.98 EX.VAT
£23.98 INC.VAT

VIDEO ON-LINE

Clarke STAPLE/ NAIL GUNS

CONSN18LiB

FROM ONLY £18.98 EX.VAT
£22.79 INC.VAT

NEW

SPARE NAILS / STAPLES IN STOCK

ELECTRIC AND CORDLESS MODELS IN STOCK

MODEL	VOLTS	BATTS	EXC.VAT	INC.VAT
CCD180	18V	1	£36.99	£44.99
CCD240	24V	1	£39.98	£47.98
Bosch PSR18	18V	1	£54.99	£66.99
CON18Ni	18V	2 x Ni-Cd	£59.98	£71.98
CON18Li	18V	2 x Li-Ion	£84.99	£101.99

Clarke STATIC PHASE CONVERTERS

PC60

- Run big 3 phase woodworking machines from 1 phase supply
- Variable output power to match HP of motor to be run

ROTARY PHASE CONVERTERS ALSO IN STOCK

CONVERT 230V 1PH TO 400V 3PH

MODEL	MAX. MOTOR HP	FUSE	EXC.VAT	INC.VAT
PC20	2HP	10Amps	£209.00	£250.80
PC40	3.5HP	20Amps	£249.98	£298.80
PC60	5.5HP	32Amps	£299.00	£358.80

FROM ONLY £209.00 EX.VAT
£250.80 INC.VAT

Clarke 4" BELT/ 8" DISC SANDER

- Includes two tables

CS4-8

£139.98 EX.VAT
£167.98 INC.VAT

Clarke QUALITY CAST IRON STOVES

OVER 22 QUALITY STYLES ON DISPLAY

POT BELLY

11.8kW **6.9kW**

£89.98 EX.VAT
£107.98 INC.VAT

LARGE & XL MODELS IN STOCK

BARREL

£209.00 EX.VAT
£250.80 INC.VAT

SAVE £60 inc.VAT

FLUES, COWLS & ACCESSORIES IN STOCK

PRICE CUT NOW ONLY
£199.00 EX.VAT
£238.80 INC.VAT

BUCKINGHAM

6kW

Clarke WET & DRY VACUUM CLEANERS

VAC KING

- Compact, high performance wet & dry vacuum cleaners for use around the home, workshop, garage etc.

SS = Stainless Steel

FROM ONLY £47.98 EX.VAT
£57.98 INC.VAT

MODEL	MOTOR	CAPACITY	EXC.VAT	INC.VAT
CVAC20P	1250W	16/12ltr	£47.99	£57.99
CVAC20SS*	1400W	16/12ltr	£59.98	£71.98
CVAC25SS*	1400W	19/17ltr	£64.99	£77.99
CVAC30SSR	1400W	24/21ltr	£86.99	£104.99

Clarke STAPLE/ NAIL GUNS

CONSN18LiB

FROM ONLY £39.98 EX.VAT
£47.98 INC.VAT

NEW

SPARE NAILS / STAPLES IN STOCK

ELECTRIC AND CORDLESS MODELS IN STOCK

MODEL	TYPE	GAUGE	EXC.VAT	INC.VAT
CESN61*	Electric	22/18	£18.99	£22.79
CCT48	Cordless			
	4.8v Ni-MH	22/18	£24.99	£29.99
CESN62	Electric	18/18	£39.98	£47.98
CONSN18LiB	Cordless			
NEW	18v Lithium-Ion	18/18	£99.98	£119.98

Clarke CIRCULAR SAWS

CON185

- Great range of DIY and professional saws
- Ideal for bevel cutting (0-45°)

*Includes laser guide

FROM ONLY £34.98 EX.VAT
£41.98 INC.VAT

MODEL	MOTOR	MAX CUT (mm)	EXC.VAT	INC.VAT
CCS185B	1200W	65/44	£34.99	£41.99
CON185*	1600W	60/40	£54.99	£65.99
CS2	1300W	60/45	£59.98	£71.98

*** was £68.39 inc.VAT**

Clarke DISC SANDER (305MM)

- Powerful, bench mounted disc sander • 900W
- No load disc speed: 1490rpm
- 305mm Disc Dia. (1 x 60 grit sanding disc included)
- Dust extraction port

CDS300B

£119.98 EX.VAT
£143.98 INC.VAT

Clarke CLAMPS

HUGE CHOICE OF SASH, SPRING, SCREW, SPREADER AND G-CLAMPS

UP TO 1800mm CAPACITY

Clarke HARDWOOD WORKBENCH

- Includes bench dogs and guide holes for variable work positioning • 2 Heavy Duty Vices
- Large storage draw • Sunken tool trough
- LxWxH 1520x620x855mm

CHB1500

£129.98 EX.VAT
£155.98 INC.VAT

Clarke BELT SANDERS

Clarke CONTRACTOR

- Ideal for surface removal, sanding and finishing

TRUKITA

ABRASIVE SANDING BELTS IN STOCK

BS1

FROM ONLY £29.98 EX.VAT
£35.98 INC.VAT

MODEL	MOTOR	M/MIN	EXC.VAT	INC.VAT
Clarke BS1	900W	380	£29.98	£35.98
Clarke CBS2	1200W	480	£69.98	£83.98
Makita 9911	650W	75-270	£94.99	£113.99

Clarke SHEET SANDERS

CON300

FROM ONLY £13.98 EX.VAT
£16.79 INC.VAT

MODEL	SHEET SIZE	MOTOR	EXC.VAT	INC.VAT
CON200	190X90mm	150W	£13.99	£16.79
CON300	230X115mm	330W	£32.99	£39.99
Makita	112X102mm	200W	£54.99	£65.99

BO4555*

Clarke PORTABLE THICKNESS

- Max thickness cap. 125mm and 250mm wide
- Planing depths adjustable from 0-2.5mm
- Powerful 1250W motor
- 8000rpm no-load speed

CPT250

£189.98 EX.VAT
£227.98 INC.VAT

Clarke BOLTLESS SHELVING BENCHES

Simple fast assembly in minutes using only a hammer

FROM ONLY £29.98 EX.VAT
£35.98 INC.VAT

SAVE 10%

WHEN YOU BUY ANY MIX OF 5 FROM THIS RANGE SAVE AT LEAST £17.99 INC.VAT

CHOICE OF 5 COLOURS

RED, BLUE, BLACK, SILVER & GALVANISED STEEL

MODEL	DIMS WxDxH(mm)	EXC.VAT	INC.VAT
150kg	800x300x1500	£29.98	£35.98
350kg	900x400x1800	£49.98	£59.98

ALSO EXTRA WIDE INDUSTRIAL UNITS AVAILABLE

150 KG (evenly distributed) Strong 9mm fibreglass shelves **PER SHELF**

350 KG (evenly distributed) Strong 12mm fibreglass shelves **PER SHELF**

Clarke OSCILLATING BOBBIN SANDER

Provides exceptional finishes for deep & wide work pieces, front edges & narrow inner curves

- Dust collection port
- Inc. 6 sanding sleeves/bobbins
- 330mm table height • 16mm oscillating stroke

COBS1

ONLY £119.98 EX.VAT
£143.98 INC.VAT

Clarke PLANERS & THICKNESSERS

CPT800

- Ideal for DIY & Hobby use
- Dual purpose, for both finishing & sizing of timber

FROM ONLY £169.98 EX.VAT
£203.98 INC.VAT

MODEL	PLANING WIDTH	MAX THICK. CAPACITY	EXC.VAT	INC.VAT
CPT600	6"	120mm	£169.98	£203.98
CPT800	8"	120mm	£199.98	£239.98
CPT1000	10"	120mm	£269.98	£323.98

Clarke QUALITY CAST IRON STOVES

BUCKINGHAM

6kW

£209.00 EX.VAT
£250.80 INC.VAT

SAVE £60 inc.VAT

FLUES, COWLS & ACCESSORIES IN STOCK

PRICE CUT NOW ONLY
£199.00 EX.VAT
£238.80 INC.VAT

BUCKINGHAM

6kW

Clarke SHEET SANDERS

CON300

FROM ONLY £13.98 EX.VAT
£16.79 INC.VAT

MODEL	SHEET SIZE	MOTOR	EXC.VAT	INC.VAT
CON200	190X90mm	150W	£13.99	£16.79
CON300	230X115mm	330W	£32.99	£39.99
Makita	112X102mm	200W	£54.99	£65.99

BO4555*

Clarke 10" (254MM) SLIDING COMPOUND MITRE SAW

- For fast, accurate cross, bevel & mitre cutting in most hard & soft woods
- 1800W motor
- Laser guide
- 78mm max depth of cut

£129.98 EXC.VAT
£155.98 INC.VAT
CMS10S2

GREAT NEW WEBSITE

NOW OVER **17,000** PRODUCTS ONLINE!

For hard-to-find, specialist items visit the **Xtra** section on machinemart.co.uk

FREE 500 PAGE CATALOGUE

Over **1250** PRICE CUTS & NEW PRODUCTS



GET YOUR FREE COPY NOW!

• IN-STORE
• ONLINE
• PHONE
0844 880 1265

MITRE SAWS

TC-SM 2534

Quality Range of Mitre saws and blades in stock

MODEL	BLADE DIA/ BORE (mm)	MAX CUT DEPTH/CROSS	EXC. VAT	INC. VAT
Einhell TH-MS 2112	210/30	55/120mm	£56.99	£68.39
Evolution Furi 3	210/25.4	60/220mm	£119.98	£143.98
Einhell TC-SM2534	250/30	75/340mm	£159.98	£191.98
Makita LS1040	260/30	95/130mm	£199.98	£239.98

Clarke MORTISING MACHINE

CBM1B

- Accurately creates deep square recesses
- Table size 150 x 340mm • Max. chisel stroke 76mm
- Robust cast iron base & column ensures stability & accuracy
- 95mm depth of cut

CHISELS AVAILABLE FROM £8.39 INC.VAT

Clarke BENCH BANDSAWS

TC-SB200

Produce fast, precise mitre & longitudinal cuts

- Cuts in wood, plastic, etc.

MODEL	MOTOR	THROAT SIZE	EXC.VAT	INC.VAT
TC-SB200	180W	8"	£99.98	£119.98
CBS190	350W	7.5"	£114.99	£137.99

Clarke PROFESSIONAL BANDSAWS

Top Quality Bandsaws - ideal for professional workshop use. Strong steel body with solid cast iron table featuring induction motors

- Table tilts 45°
- Adjustable blade guide
- Supplied with stand, 4TPI wood cutting blade, rip fence, mitre guide, mitre gauge and push stick

Models also feature: Multi-step dust extraction outlet, Removable dust tray, Flexible LED worklight, Blade tensioning control.

MODEL	THROAT DEPTH	MAX CUT 90°	MAX CUT 45°	EXC.VAT	INC.VAT
CBS300	305mm/12"	165mm	115mm	£349.98	£419.98
CBS350	340mm/14"	225mm	160mm	£449.00	£538.80

Clarke DETAIL SANDERS

CDS-1V

Perfect for smooth and fine finishing along with hard to reach areas or curved surfaces

ALL MODELS INC. SANDING SHEETS

MODEL	WATTS	EXC.VAT	INC.VAT
PS105	105W	£17.99	£21.59
RT-0S13	130W	£22.99	£27.59
CDS-1V	280W	£24.99	£29.99

Clarke MITRESAW STAND

CFMSS1

Suitable for most sizes/makes of saw

- Inc. outriggers & rollers

NEW FOLDING MITRE SAW STAND IN STOCK - CONW11 ONLY £119.98 INC.VAT

Clarke DRILL PRESSES

CDP152B

Range of precision bench & floor presses for enthusiast, engineering & industrial applications

NEW RANGE

B = Bench mounted
F = Floor standing
V = Variable speed

Clarke MULTI FUNCTION TOOL WITH ACCESSORY KIT

CMFT250

Great for sawing, cutting, sanding, polishing, chiselling & much more • 250W motor

- Variable speed

MODEL	MOTOR (W)	SPEEDS	EXC. VAT	INC. VAT
CDP5EB	350 / 5	5	£59.98	£71.98
CDP102B	350 / 5	5	£69.98	£83.98
CDP152B	450 / 12	12	£119.98	£143.98
CDP202B	450 / 16	16	£159.98	£191.98
CDP10E	370 / 12	12	£169.98	£203.98
CDP352F	550 / 16	16	£199.98	£239.98
CDP350V	550 / V	V	£219.00	£262.80
CDP502F	1100 / 12	12	£449.00	£538.80

Clarke BOSCH JIGSAWS

CJS380

DIY #Professional

MODEL	POWER (W)	DEPTH OF CUT (WOOD/STEEL)	EXC. VAT	INC. VAT
Clarke CJS380*	420W	55/6mm	£12.99	£15.59
Clarke CON750#	750W	80/10mm	£24.99	£29.99
Bosch PS1700E*	500W	70/4mm	£44.99	£53.99
Einhell RT-JS 85	85W	75/5mm	£49.98	£59.98

Clarke 13" MINI WOOD LATHE

CWL325V

Ideal for enthusiasts/hobbyists with small workshops

- 325mm distance between centres • 200mm max. turning capacity (dia) • 0.2HP motor

Clarke ROUTER TABLE

CR1

Router not included

Converts your router into a stationary router table

- Suitable for most routers (up to 155mm dia. Base plate)

Clarke BOSCH CONTRACTOR ROUTERS

CR2

Powerful heavy duty machines ideal for trade and DIY use

CR2 INCLUDES 15 PIECE KIT WORTH OVER £20

Clarke BENCH GRINDERS & STANDS

Stands come complete with bolt mountings and feet anchor holes

STANDS IN STOCK FROM ONLY £37.98 EXC. VAT £47.98 INC. VAT

6" & 8" AVAILABLE WITH LIGHT

Clarke BISCUIT JOINTER

BT-BJ900

- 11000rpm Operating Speed
- 860W Motor • 14mm Cutting Depth • Inc. dust bag and storage case

Clarke SCROLL SAWS

CSS16V

50mm max cut thickness

- Air-blower removes dust from cutting area
- Table tilts 0-45°

MODEL	MOTOR	SPEED (RPM)	EXC. VAT	INC. VAT
CSS400B	85W	1450	£69.98	£83.98
CSS16V	120W	400-1700	£79.98	£95.98
TH-SAS05E	1200W	400-1600	£79.98	£95.98

Clarke 12" DOVETAIL JIG

CDTJ12

Simple, easy to set up & use for producing a variety of joints

- Cuts work pieces with a thickness of 8-32mm • Includes a 1/2" comb template guide & holes for bench mounting

Clarke ROUTERS

CR1C

DIY

MODEL	MOTOR (W)	PLUNGE (mm)	EXC.VAT	INC.VAT
CR1C*	1200	0-50	£39.98	£47.98
Bosch	1400	0-55	£79.98	£95.98
POF1400ACE				
CR2	2100	0-60	£109.98	£131.98

Clarke ROUTERS

CR2

CR2 INCLUDES 15 PIECE KIT WORTH OVER £20

CR1C

DIY

MODEL	DUTY	WHEEL DIA.	EXC.VAT	INC.VAT
CBG6RP	DIY	150mm	£29.98	£35.98
CBG6RZ	PRO	150mm	£39.98	£47.98
CBG6RSC	HD	150mm	£49.98	£59.98
CBG6SB	PRO	150mm	£49.98	£59.98
CBG6RWC	HD	150mm	£54.99	£65.99
CBG8W (wet) #HD		150/200mm	£49.98	£59.98

VISIT YOUR LOCAL SUPERSTORE OPEN MON-FRI 8.30-6.00, SAT 8.30-5.30, SUN 10.00-4.00

BARNSELY Pontefract Rd, Barnsley, S71 1EZ	01226 732297	EXETER 16 Trusham Rd, EX2 80G	01392 256 744	MIDDLESBROUGH Mandale Triangle, Thornaby	01642 677881
B'HAM GREAT BARR 4 Birmingham Rd, B'HAM HAY MILLS 1152 Coventry Rd, Hay Mills	0121 358 7977	GLASGOW 50 Lobbey Hill Rd, NE8 4YJ	0191 493 2520	NORWICH 282a Heigham St, NR2 4LZ	01603 766402
BOLTON 1 Thynne St, BL3 6BD	0121 7713433	GLoucester 280 St Western Rd, G4 9EJ	0141 332 9231	NOTTINGHAM 211 Lower Parliament St.	0115 956 1811
BRADFORD 125-107 Manningham Lane, BD1 3BN	01204 368799	GLoucester 221A Barton St, GL1 4HY	01452 417 949	PETERBOROUGH 417 Lincoln Rd, Millfield	01733 311770
BRISTOL 1-3 Church Rd, Lawrence Hill, BS5 9JJ	01273 390962	GRimsby ELLIS WAY, DN32 9BD	01472 354435	PLYMOUTH 58-64 Embankment Rd, PL4 9HY	01752 254050
BURTON UPON TRENT 12a Lichfield St, DE14 3QZ	01283 564 708	HULL 8-10 Holderness Rd, HU9 1EG	01482 223161	POOLE 137-139 Bournemouth Rd, Parkstone	01202 717913
CAMBRIDGE 181-183 Histon Road, Cambridge, CB4 3HL	01223 326275	ILFRORD 746-748 Eastern Ave, IG2 7HU	0208 519 4286	PORTSMOUTH 277-283 Copnor Rd, Copnor	023 9265 4777
CARDIFF 44-46 City Rd, CF24 3DN	029 2046 5424	IPSWICH Unit 1 Ipswich Trade Centre, Commercial Road	01473 221253	PRESTON 53 Blackpool Rd, PR2 6BU	01772 703263
CARLISLE 85 London Rd, CA1 2LG	01228 591666	LEICESTER 69 Melton Rd, LE4 6PN	0113 231 0400	SHEFFIELD 453 London Rd, Heeley, S2 4HJ	0114 258 0831
CHELTEMHAM 84 Fairview Road, GL52 2EH	01242 514 402	LINCOLN Unit 5, The Pelham Centre, LNS 8HG	01522 543 036	SIDCUP 13 Blackfen Parade, Blackfen Rd, SouthAMPTON	0114 261 0888
CHESTER 43-45 St. James Street, CH1 3EY	01244 311258	LIVERPOOL 80-88 London Rd, L3 5NF	0151 709 4484	SOUTHAMPTON 516-518 Portsmouth Rd.	0208 3055 7268
COLCHESTER 4 North Station Rd, CO1 1RE	01206 762831	LONDON CATFORD 289/291 Southend Lane SE6 3RS	0208 695 5684	SOUTHEND 1139-1141 London Rd, Leigh on Sea	01702 483 742
COVENTRY Bishop St, CV1 1HT	024 7622 4227	LONDON F6 Kendal Parade, Edmonton N18	020 8803 0861	STOKE-ON-TRENT 382-396 Waterloo Rd, Hanley	0182 287321
CROYDON 423-427 Brighton Rd, Sth Croydon	020 8762 0640	LONDON S05 503-507 Le Bridge Rd, Leyton, E10	020 8558 8284	SUNDERLAND 13-15 Ryhope Rd, Grangeouten	0191 510 8773
DARLINGTON 214 Northgate, DL1 1RB	01325 380 841	LONDON 100 The Highway, Docklands	020 7488 2129	SWANSEA 7 Sarnlet Rd, Liansamlet, SA7 9AG	01792 792969
DEAL (KENT) 182-186 High St, CT14 6BQ	01304 373 434	LUTON Unit 1, 326 Unstable Rd, Luton LU4 8JS	01582 728 063	SWINDON 21 Victoria Rd, SN1 3AV	01793 491717
DERBY Derwent St, DE1 2ED	01332 290 931	MAIDSTONE 57 Upper Stone St, ME15 6HE	01622 769 572	TWICKENHAM 83-85 Heath Rd, TW1 4AW	020 8892 9117
DONCASTER Wheatley Hall Road	01302 245 999	MANCHESTER ALTRINCHAM 71 Manchester Rd, Altrincham	0161 942 666	WARRINGTON Unit 3, Hawley's Trade Pk.	01925 630 937
DUNDEE 24-26 Trades Lane, DD1 3ET	01382 225 910	MANCHESTER CENTRAL 209 Bury New Road M8 8DU	0161 241 1851	WIGAN 2 Harrison Street, WNS 9AU	01942 323 785
EDINBURGH 163-171 Piersfield Terrace	0131 659 5949	MANCHESTER OPENSHAW Unit 5, Tower Mill, Ashton Old Rd	01621 223 8376	WOLVERHAMPTON Parkfield Rd, Bilston	01902 494186
		MANSFIELD 169 Chesterfield Rd, South	01623 622160	WORCESTER 48a Upper Tything, WR1 1JZ	01905 723451

OPEN 7 DAYS

4 EASY WAYS TO BUY...

IN-STORE
65 SUPERSTORES

ONLINE
www.machinemart.co.uk

MAIL ORDER
0115 956 5555

CLICK & COLLECT

In brief...

EASY LAYOUT WITH PARF

Designed by well-known woodworker Peter Parfitt, the UJK Technology Parf Guide System (PGS) has been developed jointly with Axminster Tools & Machinery. Manufacturing of the system takes place at Axminster in Devon under the UJK Technology brand name.

The Parf Guide System (PGS) is a highly

accurate method of laying out a pattern of 20mm holes in a bench top or work surface to create a track saw cutting station. Using the PGS, this task is both quick and easy, producing spot-on results every time. With an accurate pattern of 20mm holes and a set of Veritas Parf Dogs, you will be able to make the perfect right angle or 45° cuts with a guiderail and track saw.

The PGS provides an infallible method of making a track saw cutting station on site in less than 30 minutes, which means that you'll be able to construct a custom bench top or portable cutting board whenever the need arises.

Based on Pythagoras' theorem, the PGS uses two Parf sticks along with a 3mm drill

guide and 3mm drill bit to create an accurately placed series of holes with the rows at perfect right angles to the columns. Then the guide block and the special 20mm bit come into play to produce the final pattern of 20mm holes.

The Parf Guide System comprises two Parf Sticks, which are 1m long, with a series of 3mm holes along the length at 96mm centres; a 3mm drill guide with 3mm drill bit and three 3mm guide pins. A guide block and a special 20mm TC drill bit with a 3mm centre guide are also supplied.

Priced at £99.96, see www.axminster.co.uk. Please note that prices include VAT and are correct at the time of publication but may be subject to change without notice.

MUDDY FOOTPRINTS NO MORE!

With the UK's changeable weather it is hard to avoid wet and mud indoors so keeping wood flooring in top condition is a priority. Osmo is answering the need for a good floor cleaner and protector with its environmentally friendly range of quality products.

Osmo's cleaning and maintenance wax-oils help keep wooden floors looking as good as the day they were first installed. Made from natural waxes and oils, these products are specifically tailored to the various properties of timber and to the specific demands of the areas in which wood is used.

Osmo's liquid wax cleaner is designed for occasional intensive maintenance and reconditioning which revitalises, maintains and enhances wooden floors. Specifically developed to take care of stubborn stains on oil and wax treated flooring, simply apply thinly to the floor with a lint-free cloth and polish.

For a more regular cleaning regime, Osmo's Wash and Care is highly effective and water-soluble for quick, easy and thorough floor maintenance. Suitable to apply in high traffic areas, this product cleans and freshens the floor at the same time.

Osmo also offers a four-piece Opti-Set, which includes a telescopic handle, dust-mop and micro-mop, plus an active fibre cloth. For stockist details and to find out more, see www.osmouk.com.



A NEW DYNAMIC DUO

Wolf Professional brand has introduced its next generation of 20V Lithium-ion cordless power tools to meet the demands of professional and serious DIY users.

Both the new 20V Li-ion combi impact drill/driver and impact driver are engineered in the tradition of Wolf Power Tools that has a heritage spanning over 115 years. Evidence of this can be seen in the engineering and attention to detail of these new offerings. Compact, lightweight and balanced for comfort, with



a soft grip handle, they are designed to meet the rigours and demands of regular use at affordable prices.

The combi impact drill/driver features include: 13mm steel keyless locking chuck; 16 torque settings up to 35Nm and a variable two-speed gearbox. Supplied with a one-hour charger, 20V Li-ion battery, belt clip and carry case.

The impact driver features an impressive 150Nm torque; 1/4in Hex drive; variable-speed control up to 2,000rpm; impact rate up to 3,000bpm and forward and reverse function. Also supplied with a one-hour charger, 20V Li-ion battery, belt clip and carry case. Prices start from £89.99; see www.ukhs.tv to find out more.

SANDING WITH THE PROS

Mirka is expanding its Pneumatic Random Orbital Sanders (PROS) range with the addition of two new dust bag machines designed for multiple sanding applications, together with a new fleece dust bag. This has been developed to increase the dust collection capacity of the sander and improve the airflow, which will enable users to work in a healthier, dust-free environment.

The new PROS 550DB and 650DB provide effective and durable tools for professional sanding. These machines are built for maximum dust extraction at low suction power and have a low noise level even when operating at their 12,000rpm maximum. The PROS weighs in at less than 1kg, and its ergonomic design makes it user-friendly, with plenty



of finger space for the controls.

The sanders' innovative features include a revolutionary brake seal, which eliminates the possibility of causing deep marks in the surface when the fast rotating abrasive first touches the workpiece.

The PROS 550DB is available with 125mm pads and the PROS 650DB comes with 150mm pads. Both are equipped with a dust extraction hose, pneumatic hose, fastening strips and fleece dust bag. Priced at £254.81, see www.mirka.com/uk.



KSS Circular Saw Series

The most comprehensive crosscut saw range in the world

Mafell AG have a full range of their Multi Function 5 in 1 saw systems to suit all requirements. From the KSS300 which is ideally suited to the flooring industry to the KSS60 & KSS80 which have a bigger depth of cut and are ideal for roofing and cutting Jack Rafter's easily & accurately.

All saws will allow the user to perform Cross-cuts, Mitres, Compound Mitres, Plunge cuts and Rip cuts.

Three models are also available as cordless versions.



The smart stop and adjustable fence allow the saw to be used for angle cuts from -60° to +60°



The highly graduated scale permits very precise angle settings



Model	Crosscut at 90°	Cutting depth at 90°	Cutting depth at 45°	Angle cuts	Available in Cordless
KSS300	300mm	40mm	27mm	-45° to +60°	Yes (18v)
KSS400	400mm	49.5mm	38mm	-60° to +60°	Yes (36v)
KSS60	408mm	61mm	47mm	-60° to +60°	Yes (36v)
KSS80	370mm	82mm	55.5mm	-60° to +50°	No

With saw in hand **PART 2**

Continuing his reflections on sawing by hand, Robin Gates explores the idiosyncrasies of vintage saws and makes a simple peg rack to keep them handy

Saws are time-travelling tools reaching back through centuries. On a quiet day at the bench, the rhythmic rasp and forest fragrance of timber being sawn could be from a village carpenter's workshop in Georgian England or a Viking shipyard.

When I'm in tune with the saw I feel its slightest upset and react with a tilt or turn of the wrist almost without thinking, but if the saw and I are not speaking it will flounder in my grasp like an oar out of its rowlock and I'll get nowhere.

A relaxed grip (**photo 1**) is essential. My old school woodwork and music master Mr Ayling showed me this 45 years ago; holding his tenon saw as lightly as his conductor's baton. Needless to say his mortise & tenon joints went together as sweetly as two bars of Mozart.

Besides cutting timber to size, a spell of sawing brings some personal benefits, too – it's a holistic workout. When the saw

is running freely my worries sink into the shadows of the workshop, and for aerobic exercise a long rip cut on a summer afternoon is hard to beat. The sawdusty sweat on my face and shirt stuck to my back only seem to confirm that I'm doing myself good while doing something useful.

Idiosyncrasies

When I was a kid, my Dad's saws hung from nails in the garden shed like swords in a castle armoury, and perhaps it's down to sentiment that over the years I've gravitated towards similar old saws. As a consequence, I've grown accustomed to their idiosyncrasies – both good and bad. The most obvious of these is corrosion. Wet and dry paper, WD40 and elbow grease restore most blades to a usable state but if the rust resembles a crème brûlée caramelised by a blow torch, I find the hardened edge of an engineer's bearing scraper more effective.



Pax Gent's saw is handy for trimming mouldings to length



1

A relaxed grip keeps the saw running sweetly

With a vintage saw in hand I feel connected with the long-gone craftsmen whose efforts have been sweated into it, and honour-bound to use it well. It's the handle in particular that grabs me; a shape developed over generations with a place for every finger in its extravagant curves – something I didn't appreciate until I had one in hand.

My first was a tenon saw pulled from a box of junk in Gosport over a century after it left Richard Ibbotson's works in Sheffield (**photo 2**). The fit of its handle is so good it holds me as much as I hold it. Those elegant and oh-so-vulnerable rearward-facing horns, which cosset the heel of the hand and slide between thumb and forefinger; the sinuous 'lamb's tongue' licking forward to the blade – they are a perfect marriage of form and function developed over generations. Another detail that's disappeared from the



modern handle is the stem of delicate wheat grains flexing around it (**photo 3**). Originally the wheat pattern was hand-carved by an owner to individualise a valued tool but it was eventually taken up by manufacturers using high-speed cutters and offered as a factory option.



2

Richard Ibbotson, one of scores of Sheffield saw makers in the 19th century



3

Wheat grain decoration on the Ibbotson tenon saw handle



4

Old saw nuts require a special forked bit



5

Groves & Sons' dovetail saw handle fits the hand superbly



6

Sawing a tough holly log requires sharp well-set teeth

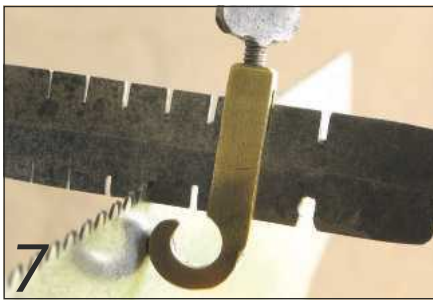

7

The saw wrist levers the tooth downwards to increase its set



8

A tapered triangular file for saw sharpening



9

The damaged hardpoint teeth seen on a disposable saw

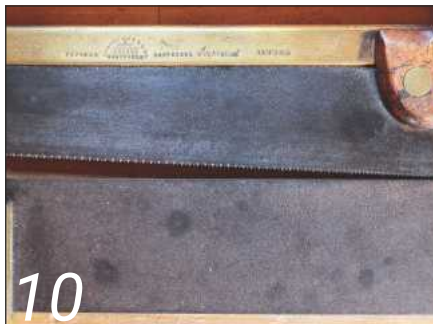

10

The heel-to-toe taper or 'cant' of old back saws is coming back into vogue



11

A dinky gent's saw is handy in a tight situation

Old back saws often have loose handles but these are easily tightened if you have the right tool – a forked bit (**photo 4**). This was the case with a mid-19th century dovetail saw made by Groves & Sons (**photo 5**) – the pinnacle of beauty in my opinion, and others seem to agree. This saw was copied in the 1990s by Independence Tools in the USA, a company subsequently bought out by Lie-Nielsen, and its likeness can be seen in LN's dovetail saw today – albeit with concessions to modern manufacturing.

First aid

A bin-load of disposable saws passed through my hands between that Ibbotson tenon saw and my next veteran, a very fit-for-purpose Spear & Jackson rip saw, but the oldies have had the shiny upstarts in retreat for some years now – a turn of events that occasionally necessitates some saw first aid.

If a saw of the older high-carbon steel is kinked it can usually be straightened with some persistence from the rounded face of a ball peen hammer. Having sighted down the blade to locate the kink, I support the target spot on the head of a sledge hammer, convex side uppermost, and begin tapping.

The next problem might be that the saw binds in the kerf. The wide blade of a hand saw is often 'taper-ground' to minimise friction and avoid binding, meaning that it gets progressively thinner from cutting edge to back, and the teeth of a cross-cut



12

Folded brass backs of gent's, dovetail and tenon saws

saw are also 'set' with a slight outward bend to cut a wider kerf. I've managed to reduce binding by increasing the set using an old saw wrest, which is a fairly primitive tool (photo 7). The wrest has slots corresponding to different thicknesses of blade and is fitted over a tooth, to about half its depth, then levered downwards. A sliding brass guard prevents the tooth bending too far.

A dull tooth can be sharpened using a tapered triangular saw file – one or two strokes per tooth is usually sufficient (photo 8). In the absence of a proper saw vice for this operation I clamp the saw to the edge of the bench using G clamps and a batten. It's a bit rough and ready but the system works.

I don't know if it's a characteristic of hardpoint saws or if I've been unlucky, but those I've bought have lost their edge after only moderate use (photo 9). The teeth are heat-hardened by an induced electric current, typically revealed by a blue-black line along the cutting edge, and I suspect the process makes the steel more brittle as I've had more than a few tooth breakages. In any case, the combination of hardened steel and complex tooth geometry has defeated my best efforts with a saw file.

Where there's brass

There's nothing like the glimmer of old brass to turn my head towards a saw, and not just because it's pretty. Where there's brass there's



13 Sawing for the fun of it: a small back saw is child friendly

more weight than if there had been iron and that's a real advantage in the back of a small saw. With the extra down force of the brass back bearing on the teeth, the hand need push no harder than to post a letter. Manufacturers would offer the same saw with iron or 'best quality heavy brass back' and the brass option typically cost about 30% more (photo 12).

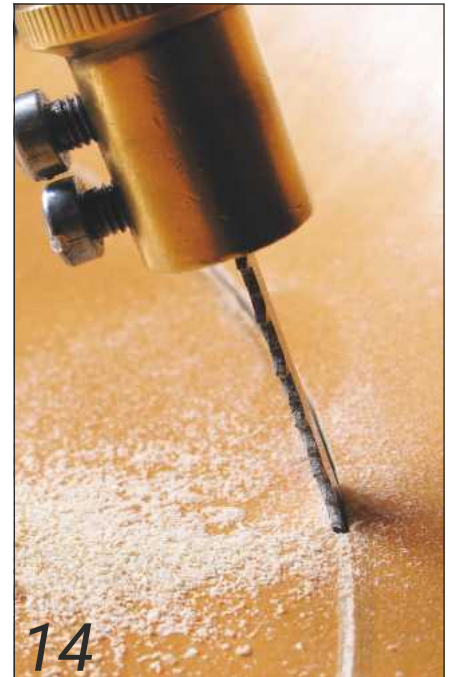

14 My beloved pad saw works like a hand-powered jigsaw



15 The pad saw's slotted handle accepts a standard hack saw blade



16 Trimming a wedged tenon flush with the coping saw



17 Carefully cutting a hollow with the Eclipse 7CP coping saw

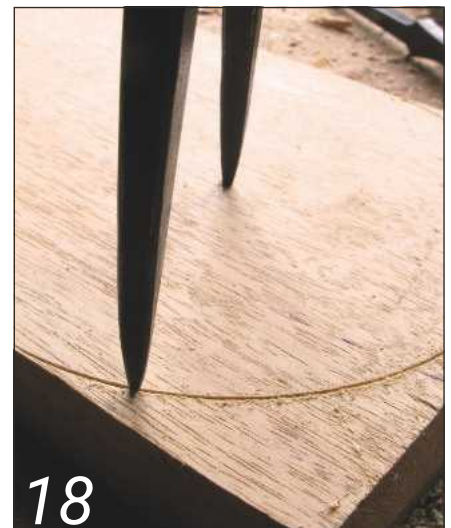

18 Wing dividers scribing an arc for the saw to follow

There's some debate over the merits of a brass back being folded over the saw plate – the method of the last 250 years – or machined with a slot into which the saw plate is glued with epoxy resin. The traditionalist claims that a folded back tensions the saw plate while protecting it from damage, allowing it to bow under pressure, thence to be tapped back into shape with a deft touch of the mallet. The modernist argues that an epoxied saw would not have bowed in the first place. I think they're both right.

A feature of old back saws coming back into vogue is the kind of taper known as 'cant' (photo 10), in which the blade narrows from heel to toe. The tenon saw illustrating this was made by Thos Turner & Co and tapers from 55mm to 45mm. I've yet to find a historic explanation of cant but today's makers claim it improves precision, causing the teeth to reach the baseline of a cut on the entry side of the kerf before doing so on the exit side, so you are less likely to saw beyond your marks.

My dinkiest back saw is the gent's saw (photo 11), distinguished by its straight handle, which I find better suited to dainty cuts. It's a 254mm cross-cutting 'Pax' model and although a veteran is still performing well, its fine teeth making a tidy job of end-grain when trimming small stock to length. Thomas Flinn & Co continues to make a dovetail version of this saw in Sheffield, the ancestral home of good saw steel, priced at around £24.



19 Laying out saws to mark peg positions on the rack



22 Cross-cut, rip, coping and bow saws hung on the rack

Unsung saws

It's rare for anyone to sing the praises of the humble pad saw (photo 14) but I'd be lost without mine. Working in tight spaces the pad saw with its retractable blade really comes into its own, and it's especially handy for cutting curves and apertures inside panels. Using quick, short strokes with a light pressure it's my hand-powered jigsaw. A useful bonus is that the slot (photo 15) in the pad accepts a standard hack saw blade, so it can be used for cutting metals and other materials, too.

One other saw I keep close at hand is the coping saw (photo 16), which slots into places where other saws get firmly stuck. The Eclipse 7CP (photo 17) with turned beech handle and chromed steel frame is a design that's remained virtually unchanged for at least 70 years. Its fine rotating blade swoops and climbs through curves like a stunt plane. Since I discovered the Swiss Pegas blades at Workshop Heaven, it cuts even better. If sawing an arc of constant radius, I find a pair of heavy wing dividers (photo 18) is ideal to scribe the line.



20 Boring holes for pegs using the sliding bevel as a guide



23 Taking and returning saws is easy

Peg rack

No matter how many saws you have there's no simpler means for storing them than a peg rack. It's just a slightly more sophisticated version of the nail hammered into the wall and has served the busy workshop for generations. Bow saws, hack saws, tenon saws – they can all be accommodated.

Using a piece of 65 x 325mm elm for the wall-plate and 12mm pine for the pegs, this rack was built to accommodate particular saws and fit into a 600mm space beside a window. Having laid out the saws (photo 19) to mark where the pegs should go, the only tricky part was boring the peg holes at a consistent angle (photo 20). I used a sliding bevel as a visual reference for the brace, set to 10°, which would be just sufficient to prevent saws being knocked down accidentally. The rack was finished with boiled linseed oil and fastened to the wall with 60mm screws, accommodating two rip saws, three cross-cuts, a coping saw and a bow saw (photo 22) – with space for more. [www](http://www.getwoodworking.com)



21 Tapering the ends of pegs to fit the holes



22 Ripping a small elm board with the tenon saw

SUPPLIERS

- Thomas Flinn & Co
- 01142 725 387
- www.flinn-garlick-saws.co.uk

- Workshop Heaven
- 01295 678 941
- www.workshopheaven.com

New premier tool joins the team

The extra-small cordless drill. Available in C-shape or T-shape.

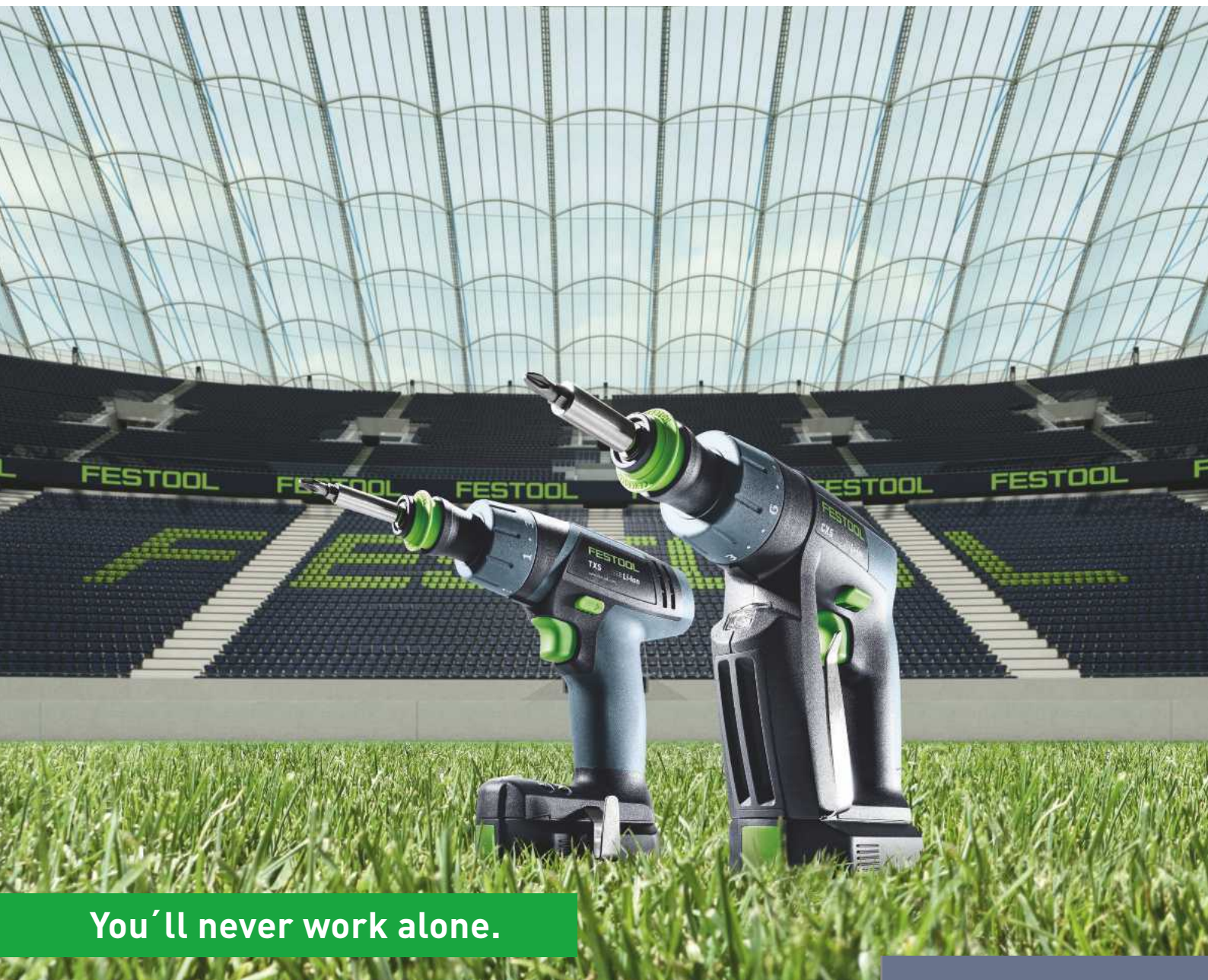

You'll never work alone.

SERVICE
all-inclusive



Light, amazingly strong and now available in the classic T-shape, these impressive cordless drills offer exceptional high-power torque, even in hard-to-reach spaces. The compact construction and even weight distribution make them ideal for working overhead. Complete with lithium-ion battery packs, CENTROTEC quick-change system and SERVICE all-inclusive, both C-shape and T-shape cordless drills are perfect for the professional user.

For more information visit your local Festool dealer or www.festool.co.uk/xs

FESTOOL

Tools for the toughest demands

www.festool.co.uk

In brief...



SAW SHARPENING FOR BEGINNERS

Chris Tribe is delighted to be working with Shane Skelton of Skelton Saws to present a new course, which takes place on 2 July. A traditional hand saw maker and saw doctor, Shane has both restored and sharpened some of the oldest and most valuable saws in the world. During this one-day course he will teach you the basic skills that will enable you to approach saw

sharpening with greater confidence, as well as guiding you towards the best tools for the job.

Saw sharpening is a skill that is often overlooked, and which has been largely lost over time. Most of us tend to shy away from sharpening our own saws, yet it is a task that is paramount to the performance of the saw.

A good quality saw that is correctly sharpened produces effortless, accurate joints. This course is both a practical demonstration and an explanation of the fundamental processes in saw sharpening; it covers the following elements: jointing, spacing, forming, setting, sharpening, test and correction.

For more details about the course, call Shane on 01723 448 202 or email skeltonsaws@gmail.com.

BRAND-NEW SHOWROOM

Anglia Tool Centre's brand-new showroom in Oxford is now open. Located on Peterley Road just off the eastern bypass of Oxford, they stock an exciting range of products from leading power tool brands, including Makita, DeWalt, Milwaukee, Bosch, Festool, Trend and many more. Like their other showrooms, there is now a demonstration area in store so you can try power tools before buying. Each product is price matched with their online prices at www.angliatoolcentre.co.uk, ensuring you always get the best deals possible.



REVOLUTIONARY NEW TIMBER FIXING

IronmongeryDirect has introduced an innovative new spiked timber fixing product to its range, designed to combat common joinery problems.

The Joyner Bolt is a unique fixing, which has been designed to overcome the shortcomings of traditional fixings, such as coach bolts and threaded rods. The bolt features an innovative square head so that it cannot be pulled through the wood as the joint is tightened, ensuring that the timber face won't be damaged. In addition, it contains eight integral spikes to immediately grip and hold the timber; this ensures the joint will not become loose over time even when it is inserted

into a hole that has been drilled too large, therefore guaranteeing an optimum and longer lasting connection.

As it can be fitted with one hand, the bolt is easy to use and is the ideal solution for tradespeople tasked with connecting timber in difficult to reach areas, such as in floors, rafters and ceiling joints. The bolt, which is brand-new to the market, is priced from just £9.40 per pack of 10 bolts. For more information, visit www.ironmongerydirect.com/joyner-bolt.

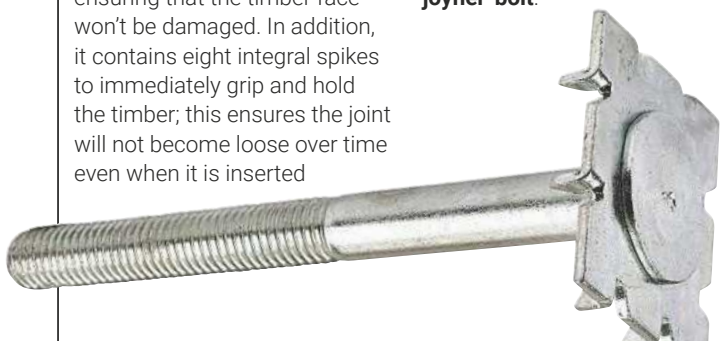

MEDAL FOR EXCELLENCE

Local furniture crafts student Philipp Stummer has been awarded a Medal for Excellence from the City & Guilds Group in recognition of his exceptional talents.

Philipp, from Leamington, was recognised for his outstanding work towards his Level 2 Furniture Making course at Royal Leamington Spa College – he is now studying for his Level 3 qualification under course leader Jamie Ward.

While studying, Philipp has set up his own business, EarthWoodCrafts – www.earthwoodcrafts.com – and is also working with furniture maker Armando Magnino on a project for the Shakespeare Birth Place Trust.

During his time at the college, Philipp has also won the college's Andrew Varah Award for the outstanding furniture-making student as well as the



Gordon Russell Award. He also exhibited at the Young Furniture Makers Exhibition at Furniture Makers' Hall.

To find out more about courses on offer at Royal Leamington Spa College, see www.warwickshire.ac.uk/courses.

Cutting Edge Technology

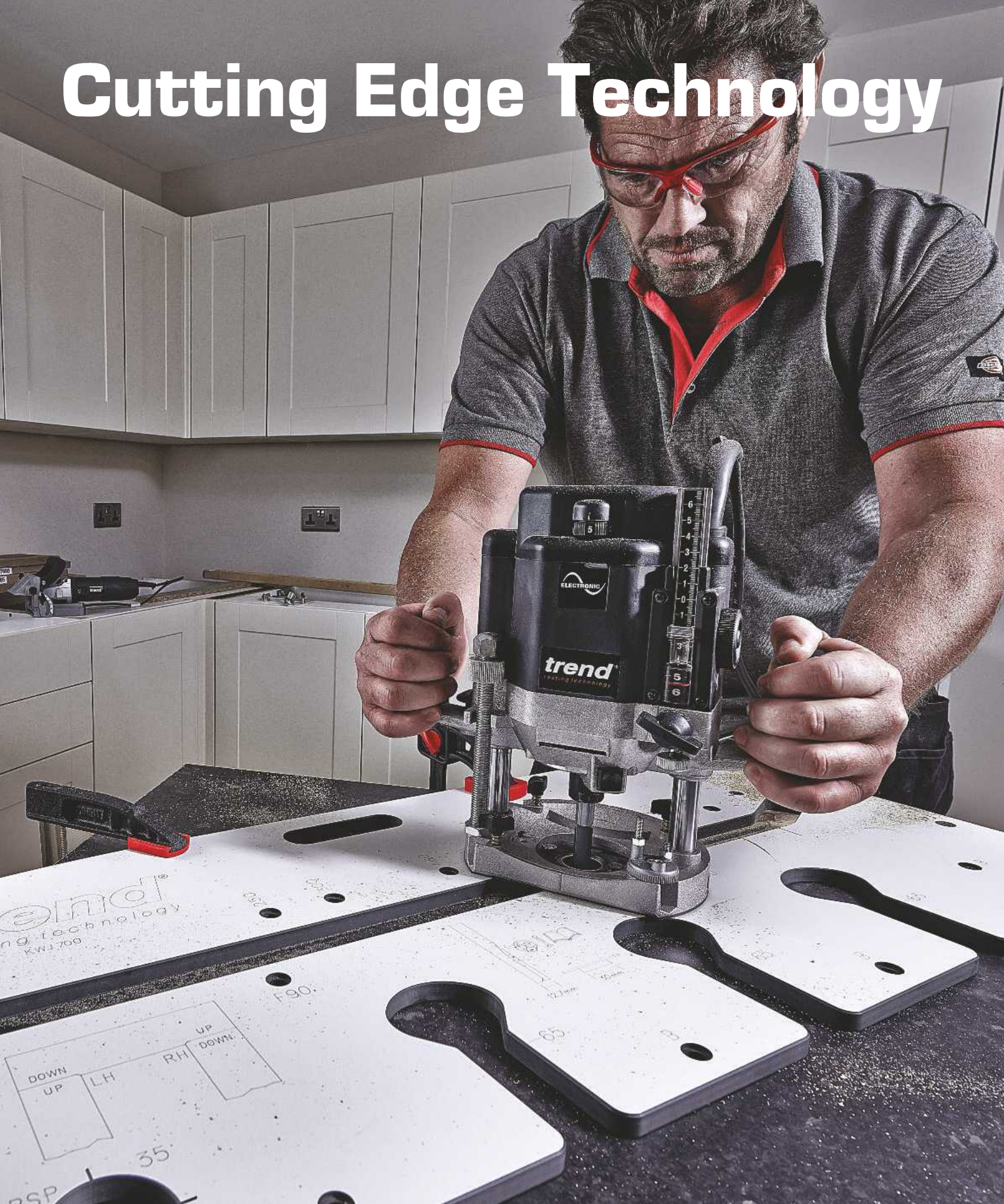

trend[®]
routing technology



www.trend-uk.com

In brief...

TAKE CONTROL OF DUST

Hilti has further optimised its harmonised Dust Removal Systems (DRS) portfolio with the launch of the upgraded VC 20-UM and VC 40-UM vacuum cleaners, which will deliver a more comfortable, safe and productive working environment.

Both products have been engineered to maximise suction in both wet and dry worksite conditions, while ergonomically designed and equipped with larger wheels for improved handling across the toughest worksites. The VC 20-UM has a dust capacity of 23kg while the VC 40-UM a larger 40kg.

They have an extended range of filters for standard, performance and dry applications, optimising the DRS depending on the task in hand. For wood and mineral applications, improved dust bags are also available.

Both the machines feature a new switch to deactivate automatic filter cleaning – known as Airboost – which allows them to be used in quiet environments.

The upgrades mark the latest development in the extensive Hilti DRS portfolio, whereby the tool, consumable,

accessory and M-class vacuum work in harmony to remove the maximum amount of dust at the point of contact.

Both new vacuums ensure the user can address key Health and Safety Executive (HSE) legislation governing onsite dust exposure as listed in the Control of Substances Hazardous to Health (COSHH) regulations, which set out maximum Workplace Exposure Limits (WEL).

The VC 20-UM and VC 40-UM can be purchased through the Hilti Fleet Management programme whereby a fixed monthly charge covers all service and repair costs over four years. For customers who prefer to own their own tools outright, Hilti Lifetime Service gives a no-cost period of two years. For more information, visit www.hilti.co.uk/vacuums.



WOODCRAFT IN WALES

The National Botanic Garden of Wales will be running its Wales Woodcraft Festival from 20–21 August this year. This event builds on the success of the Wales Tree Festival, which has been run at the Botanic Garden over the past four years.

This year, it is hoped the event will attract more amateur woodworkers, not only to learn from demonstrators, but also to take advantage of specialist tools, woods, equipment and products, all of which will be available to buy.

The Botanic Garden is situated 10 minutes from the M4 and two minutes from the A48 in Carmarthenshire, midway between Cross Hands and Carmarthen – see www.botanicgarden.wales.

DON'T GET BURNT FINGERS – USE A BOWL SANDER!

This great new package deal from

Charnwood includes their Deluxe Woodturner's Bowl Sanding Kit with 20 hook-and-loop discs of varying grit sizes, all supplied in a handy storage case.

The bowl sander is used to effortlessly



sand pieces while they are still mounted on the lathe. Simply set the lathe running and then use the foam pad to sand to a fine finish, even with intricate shapes.

The handle of the sander features a soft foam grip for extra comfort and control during long periods of use. The head can be adjusted to any angle to find the perfect position for accessing more complex designs. The four foam-backed hook-and-loop-faced sanding pads are a push fit into the head, which means no tools are required. The soft foam backing

allows the pad to change shape and take the form of the piece being sanded, with only light pressure.

Supplied with 2 × 50mm diameter hook-and-loop pads; 2 × 75mm diameter hook-and-loop pads; spanner for adjusting head angle; 10 × 50mm diameter hook-and-loop-backed discs (two of each grit: 60, 120, 180, 240 and 400); 10 × 75mm hook-and-loop-backed discs (two of each grit: 60, 120, 180, 240 and 400); and a presentation case.

The package retails at £54; more details can be found here: www.charnwood.net.



TURNING IT UP WITH MARK SANGER

Mark Sanger, recently crowned champion at the Ten Turners Turning event, is going on tour. He will be demonstrating at all the Axminster stores over the course of the next few months, starting at Warrington

on 18 June and culminating in a meeting with Richard Findley on 4 March 2017.

Mark's work features wood, mixed media, texture, form and colour, all of which are influenced by Far Eastern philosophies and cultures as well as the natural forms and textures found in nature.

Mark says: "My work is free flowing of simple form. I believe that it should evolve from the here and now, from the initial idea to completion. I may have an idea about what I am going to create, but beyond this my mind is kept open and receptive to changes that evolve along the way. On occasions, it may take a different path."

Mark will be demonstrating from 10am-4pm at the Axminster stores on the following Saturdays:

2016

- 18 June – Warrington
- 9 July – Basingstoke
- 27 August – Axminster
- 17 September – Sittingbourne
- 15 October – High Wycombe
- 12 November – Cardiff
- 10 December – North Shields

2017

- 4 March – Nuneaton

Keep up-to-date with all the latest news and events here: www.axminster.co.uk.



Wood Workers Workshop



01684 594683

www.woodworkersworkshop.co.uk
The Threshing Barn, Welland Road,
Upton upon Severn, Worcestershire, WR8 0SN

INCR

Woodpeckers

WoodRiver

WILKINSON
JIG

CLIFTON

ROUNDER
BOSS
A Tool for Fine Craftsmanship

Thomas Finn & Co.
Fine Manufacturing Ltd. 1911

EASY WOOD TOOLS

Router
Technologies

Ashley Iles

veritas

THE VERY BEST WOODWORKING TOOLS

Sourced by woodworkers for woodworkers

Quality tools from the finest UK, US & Canadian manufacturers



Peter Sefton Furniture School .com



Woodworking & Furniture Making Courses

Learn to craft wood and make fine furniture on our long and short courses at purpose-built workshops in Worcestershire

- Short Courses include**
- French Polishing & Refinishing
 - Wood Machining
 - Dovetailing & Drawer Fitting
 - Veneering & Laminating
 - Routing
 - Sharpening
 - 'Make a Box'
 - 'Make a Table'
 - Beginners Course



Sam Carter
9 month student



Rick Howie
9 month student



Veneering & Laminating
4 day course



Paul Smith
9 month student

Call us on **01684 591014**
or find us online for information on all the courses
www.peterseftonfurnitureschool.com

The Threshing Barn, Welland Road, Upton upon Severn, Worcestershire, WR8 0SN



Creative and contemporary green wood furniture courses in beautiful Devon



A range of courses focussing on the skills and techniques of green woodworking with an emphasis on design and detailing.

From a two day course learning the skills and techniques of green woodwork, to a 9 day Table Course where you will learn advanced jointing techniques and how to combine green wood with other contemporary techniques and materials.

Always starting from a fresh cut log you will learn how to cleave the wood with a froe and wedges, then shape it on the shaving horse with draw-knife and spokeshave.

All timber supplied on this course is locally sourced.

Suitable for beginners and experienced woodworkers. Prices start from just £150 for two days.

Peter Lanyon lives on the edge of Dartmoor and runs course from his workshop on the beautiful South Devon coast. He has been making furniture for over 20 years in hardwoods, softwoods and reclaimed woods. Peter specialises in working with coppice wood i.e. freshly cut unseasoned 'green' wood to make contemporary, high quality bespoke furniture.

Peter Lanyon Furniture
peterlanyonfurniture.co.uk · 07814 470432



Table Course
12th-17th July and 9th-11th
September

Introduction to
Green Wood Furniture Making
20th and 21st August

Chair Course
31st October - 5th November



Rocking Ride

Upon discovering some online plans in German, Derek Lane set about translating these and customising them to meet his requirements for a rocking motorbike for his great grandchildren

I wanted to make something but was not sure what, so while looking around the internet I found some very basic free plans for a motorbike rocker, which had no construction details and were written in German.

From this I needed to work out sizes for components by drawing a grid onto the drawings, as I knew the sheet size they had used. At this point I had to work out the parts that I wanted to change. The original had a working steering system and as the bike could be removed from the rocker assembly, I wanted it to be fixed and therefore did not want the steering to work. Another thing that I also wanted were detailed wheels as opposed to round discs.

As I progressed with the build, there were other little things that I changed, which I will explain as I go through the build.

The next thing to consider was the materials to use in the making of the rocker. Well, I had quite a few sheets of MDF sitting around of different thicknesses so they were going to be used for the majority of the project. The handle bars,

axles and foot rests had to be made of solid wood; in this case some knot-free pine of the correct thickness.

I would like to point out that at this stage of the planning, I didn't have anyone in mind when I was making the rocker – it wasn't until halfway through that I decided to give it to one of my great grandchildren, who loved it! [WW](#)



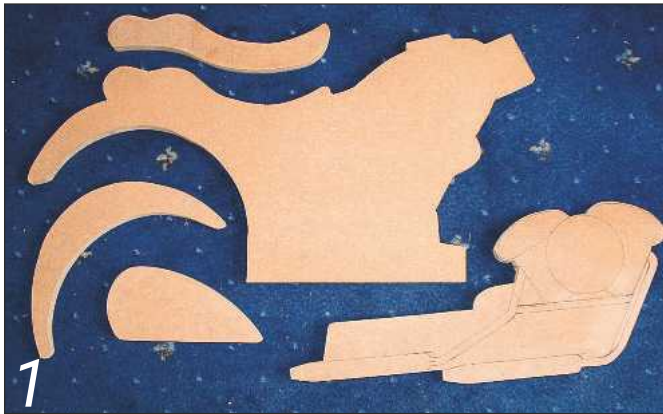

The shapes were cut out for the main components and transferred to the MDF for the first of many cuts. Where there was more than one of each item, I only cut the first and then sanded it to shape. The rest of the components were rough cut then cleaned up with a router fitted with a follower bit, which helped to speed things up tremendously. This photo shows the first cuts



Most of the parts were now cut as described above using the router for multiple parts. These were all cut from 19mm MDF. You will notice from looking at the three main body parts that one has an extra bit at the bottom; this is for fixing to the rocker assembly later



These three frame parts were then glued together to form the main carcass as well as two pieces of 10mm-thick MDF strengtheners, which were added to either side of the centre support. Everything else would be attached to this main unit

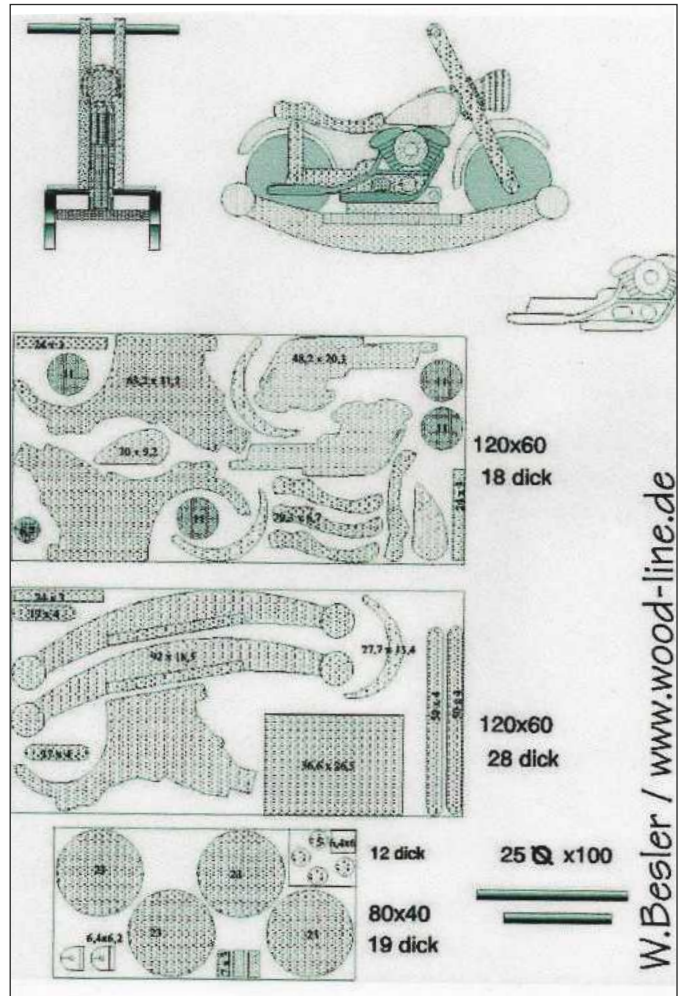

The free German plans, which I used to make the rocking motorbike



The two petrol tank panels were glued one each side of the main body where the top of the tank shape can be seen, as well as the two pieces of the seat



Once dry, all the edges were rounded over. I wanted these to be particularly smooth to make sure there were no sharp edges for children to potentially hurt themselves on. I also rounded over the tank filler neck, as you can see



Three parts of the front mudguard were joined together then rounded over as with the main body. The router pictured here shows the straight cutter with the bearing fitted, which I used for making multiple copies of the various parts

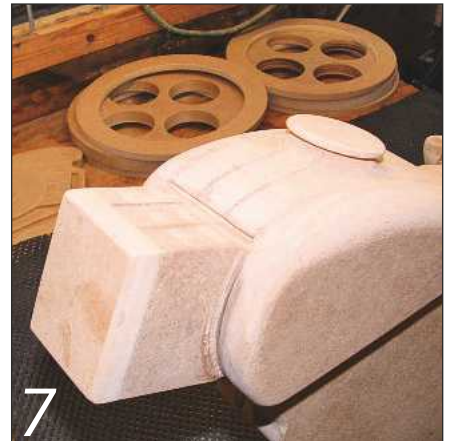

I then made up a disc for the filler cap and attached this. While I was here, I realised I didn't like the way the tank and seat joined the main body so to emphasise both of these, I undercut them to give the impression of them being separate items



Next was the engine detail. This was originally cut from a 19mm-thick piece of MDF, but didn't look right, as can be seen on my makeshift sanding table...



... so I decided to make this from one 12mm and one 6mm-thick piece of MDF for each side. The 12mm was left with just the outer shape cut out, but I also cut some detail into the 6mm piece and stuck it on to the 12mm piece



I was much happier with this little detail

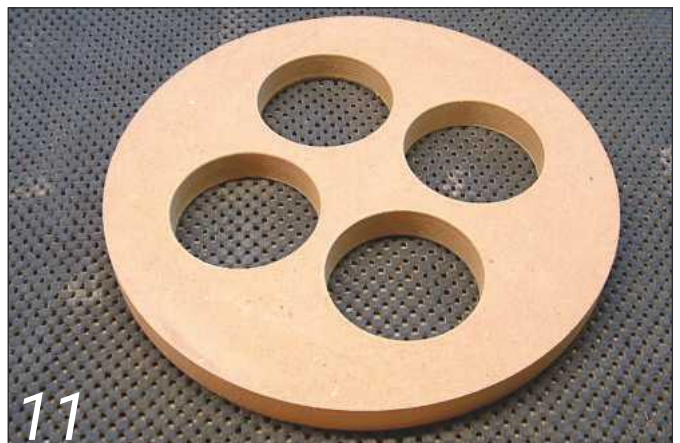

Next it was on to the wheels – here you can see the centre of one wheel. I wasn't happy with just having circles, so I decided to modify the design, as shown in step 12

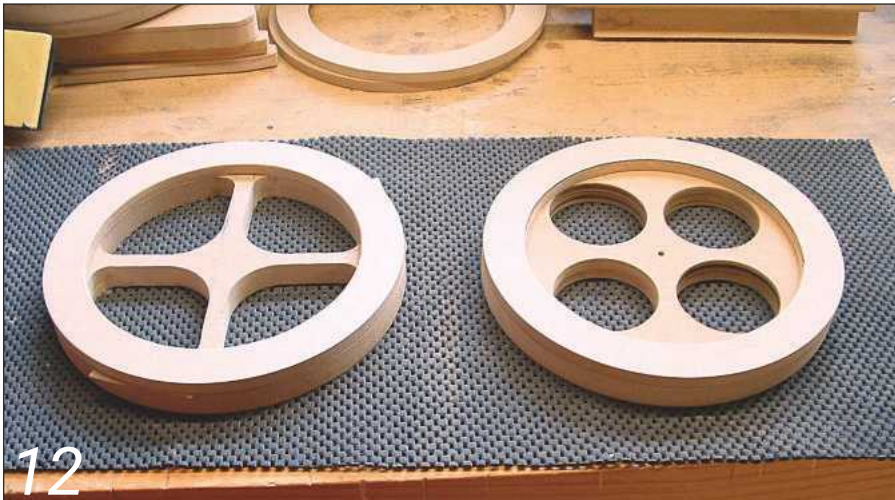

12

So after a little playing around with shapes, I came up with the design shown on the left

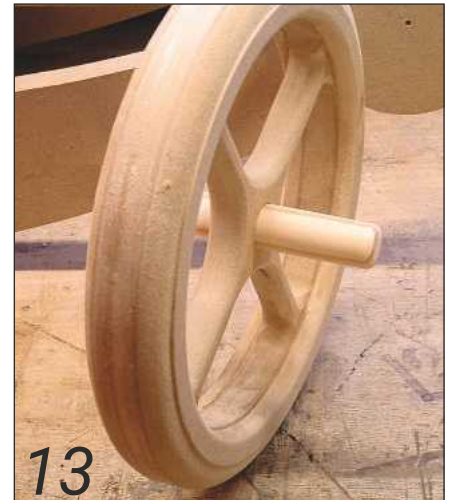

13

And after some more routing and rounding over of the edges, they were now looking like this along with the axle, which was turned on a lathe



14

After cutting the front fork bar and rear axle supports, I finished turning the handle bars, foot rest and front and rear lights. These were then glued to the main frame. As you can see, the motorbike was now starting to take shape



15

I then cut out the rocker assembly and made some large dowel pieces for the rocker end supports as well as fitting a cross member for the bike to fix to this



16

This is how it was looking with some of the parts glued on



17

After cutting the fixings for the bike to sit on the rocker assembly, a dry fit was needed to check all was OK. The wheels weren't yet glued in place as was the bike to the frame; this was done once all the painting had been completed

With the paint work completed and everything now glued into place, the motorbike was ready for the rider; I say ready as this project was made seven years ago and is still in the same condition. It has now been passed down to my great grandson's younger brother who is two-years-old, so any doubt about the strength of using MDF has passed



DEWALT®

PRECISION POINT™

NEW

HIGH PRECISION NAILING

The newly designed compact nose is 80% smaller than previous tools for improved access and visibility, ensuring that the fastener is driven with precision.

The innovative nose also detects the nailing surface minimising marking on the wood and making tool operation quick and effortless.



DNBDA15
32-64mm

15 GAUGE FINISH NAILER
DPN1564APP-XJ



DNBSB16
25-64mm

16 GAUGE FINISH NAILER
DPN1664PP-XJ



DNBT18
15-50mm

18 GAUGE BRAD NAILER
DPN1850PP-XJ

**ALSO NEW: PORTABLE, SUPER QUIET,
HIGH PERFORMANCE TWIN OUTLET COMPRESSOR**
DPC10QTC-GB

- Almost half the noise of other DEWALT compressors
- High performance: 13.8 bar operating pressure
- Oil free pump and roll cage design for improved durability



In brief...

NEW PARTNERSHIP BUILDS ON FURNITURE TRAINING HERITAGE

A new educational partnership is to continue a rich heritage of preparing furniture designers and makers for their future careers. The Rycotewood Furniture Centre has partnered with Oxford Brookes University to deliver the Furniture: Design and Make Foundation Degree and BA (Hons). Rycotewood's programmes have been validated by Oxford Brookes and will be delivered at City of Oxford College, which is part of Activate Learning.

Joe Bray, higher education programme coordinator at Activate Learning, said: "The Rycotewood name has a rich heritage in furniture design and making. The centre



has been training students in the design and craft of fine furniture since the 1930s. Our students have gone on to work for companies such as Benchmark, Matthew Burt and Philip Koomen as well as building enviable reputations as bespoke designers and makers. Students also achieve success in national competitions on an annual basis. In 2015, these included winners of the prestigious Alan Peters' Award and the Worshipful Company of Furniture Makers' Bespoke Student Awards."

The announcement follows a report published by the Quality Assurance Agency for Higher Education (QAA) in December, which highlighted student employability as a key strength of Activate Learning's higher education programmes. This means that all Activate Learning Foundation Degrees and BA Hons programmes are now delivered in partnership with Oxford Brookes University. This Degree is a full-time, two-year course and on completion, students can choose to take a further top-up year to achieve the BA (Hons) qualification. The courses are now open for entries; to find out more, visit www.activatelearning.ac.uk/universitylevel.



NEW WEBSITE FOR TRITON

Triton Tools have recently given their website a bit of a make-over and they would love it if you headed over to www.tritontools.com to have a look. The new website has even more information that's easier to find, plus improved security, and it's now also mobile-friendly.

Due to the improved security, those already registered with a MyTriton account will need to reset their password on their first visit to the new site.

Have a look for yourselves and enjoy the increased usability, easy-to-access content and a wide range of informative videos, including an interview with In'Bo, the French design team making unique wooden sunglasses, wooden bikes and skateboards.

HITACHI UNLEASHES ULTRA POWERFUL SDS-PLUS HAMMER DRILL

With a highly efficient brushless motor delivering even more power and run time when out on site, Hitachi Power Tools has launched the tougher, faster and more advanced DH18DBL/JP SDS-Plus hammer drill. Running for 50% longer per battery charge than Hitachi's conventional brushed DC motor, the impressive DH18DBL/JP hammer drill has impact energy of 2.6 Joules and a 26mm drilling capacity in concrete. Its three-mode action for powerful rotary drilling, hammer drilling or chiselling makes it a formidable tool for all those working out on site without mains power.

As with all Hitachi products, user safety is at the forefront: the hammer drill has over current protection and the Reactive Force Control (RFC) system reduces the risk of injury from tool overload. The built-in LED light allows users to work in dim and tight spaces and the battery indicator means you never need to run out of charge.

With 2 x 5.0Ah Li-ion batteries, side handle, charger and carrying case as standard and with Hitachi's three-year warranty available when registered online within four weeks of purchase, trade professionals can be assured of long service and peace of mind. For more details, see www.hitachi-powertools.co.uk.



FROM WOODWORKING NOVICE TO YOUTUBE SENSATION

In the 10 years since the launch of YouTube, the video-sharing website has become the go-to destination for guides on how to do just about anything. Woodworkers are generous folk and many are taking to YouTube to share their skills and help us all improve our craft. Tool reviews, shop tours, project ideas and tips of the trade are all available online for anyone looking for woodworking news and information.

There is a growing community of woodworkers with their own specialist YouTube channels, some of whom make their living from doing what they love, sharing projects and ideas with viewers. One of the woodworking YouTubers is April Wilkerson, Triton Brand Champion for the USA, who also provides valuable feedback on product development. April is the first to admit that she is relatively new to woodworking but with a passion for making and a determination to learn and share her knowledge, she has gained a committed following for her YouTube channel.

Find out more about how she has turned her woodworking hobby into a successful YouTube channel that is now her full-time job. To see more of April's work, read up on her projects or to download some plans, check out her website: www.wilkerdos.com, and her YouTube Channel here: www.youtube.com/user/AprilWilkersonDIY.



**NATURAL WOOD
FINISHES YOU
CAN RELY ON**



01296 481220 | osmouk.com



DECKING-OIL: Highest quality colour and protection for wood

✓ MICROPOROUS | DURABLE | UV-RESISANT | OIL-BASED | HIGH COVERAGE

Dowelmax

Tables, chairs, stools, kitchens, bedrooms, desks, bookcases, sideboards, beds, benches, doors, windows, steps, cabinets, *make them all and more with the **Dowelmax Doweling Jig***

Dowelmax Doweling Jig - No need for biscuit jointers, tenoners, morticers, screws, loose tenons etc, *make joints faster, more accurately and stronger with **Dowelmax***

The ultimate doweling jig for woodworkers!

See us on and visit:

www.dowelmax.co.uk

for more info, video and ordering.



Tel: **01352 781168** or **07773 718758**

Quality Tools to match our Service

JET

Mouldings

Certified Hardwoods

Top quality hand tools

Toishi-Onishi Japanese Waterstones

Drilling Tools made to the highest standard

COLT PROFESSIONAL TOOLS

G&S Specialist Timber

TOOLS AND MACHINERY

www.toolsandtimber.co.uk

you can order online now

Flexcut CARVING TOOLS

pfeil

WE ARE EASY TO FIND:
1 1/2 miles from the M6, J40.
Take the A66 towards Keswick,
turn left at first roundabout,
follow the Brown Signs to
The Alpaca Centre.

Open 8am to 5pm daily.
10am to 5pm Saturday.
Closed Sunday.

G&S SPECIALIST TIMBER

The Alpaca Centre, Snuff Mill Lane, Stainton, Penrith, Cumbria CA11 0ES.
Tel: 01768 891445. Fax: 01768 891443. email: info@toolsandtimber.co.uk

John Davis Woodturning Centre

... a working woodturning centre run by Woodturners for Woodturners

not just a shop



Simon Hope will be here demonstrating his extensive range of tools and equipment

Sat 16th July 2016

10 am - 4 pm

Come along and see the tools in action



The Old Stables, Chilbolton Down Farm, Stockbridge, Hampshire SO20 6BU

email: admin@johndaviswoodturning.com

Shop Open: Mon - Sat 10am - 5pm, Sun 10am - 2pm

www.johndaviswoodturning.com

Tel: 01264 811070

TOISHI OHISHI

SUPERIOR JAPANESE WATERSTONES

Favoured by Lie-Nielsen Toolworks in the USA for edge preparation, honing and final polishing.

Available from *Classic Hand Tools Ltd* and *G&S Specialist Timber*.

Single Grit Stones:

- 220 - £34.22 • 600 - £34.69 • 1000 - £43.09 • 3000 - £46.69
- 6000 - £59.89 • 8000 - £73.20 • 10000 - £93.60

Combination Stones:

- 1000/3000 - £39.49 • 1000/6000 - £57.49 • 1000/8000 - £64.50
- 3000/8000 - £64.69 • 3000/10000 - £81.00 • 6000/10000 - £82.50
- Nagura Stone - £13.09

Classic Hand Tools

G&S Specialist Timber,
Penrith,
Tel: 01768 891445
www.toolsandtimber.co.uk

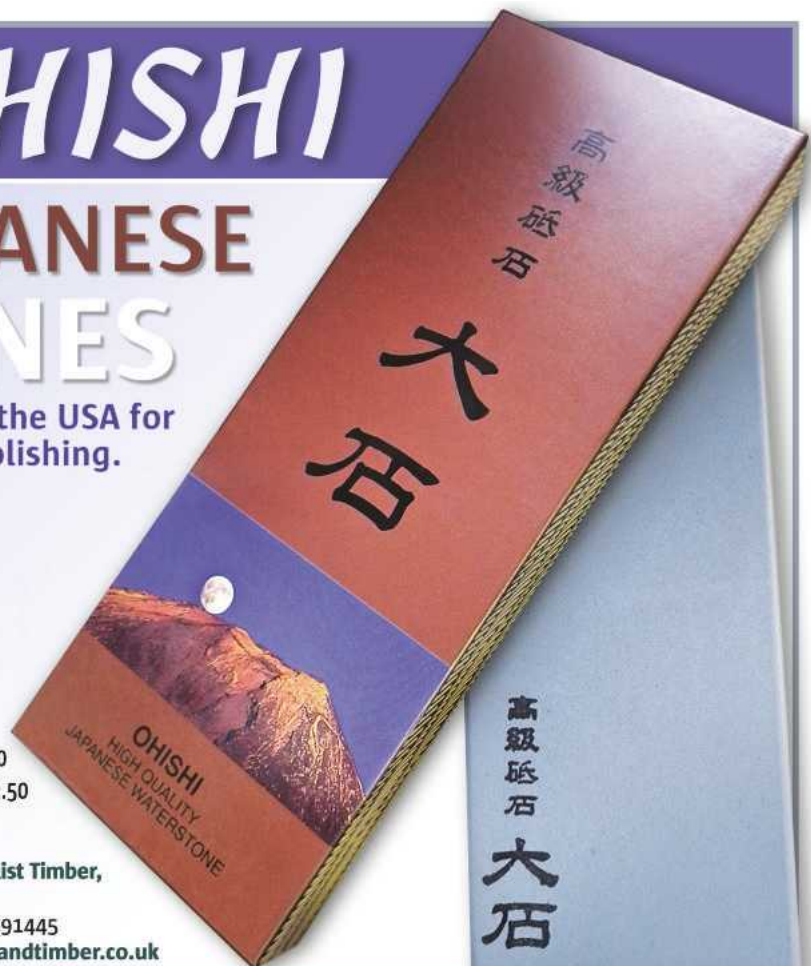

高級砥石
大石

Tel: 01473 784983 • www.classichandtools.co.uk • sales@classichandtools.co.uk



BY IAN WILKIE

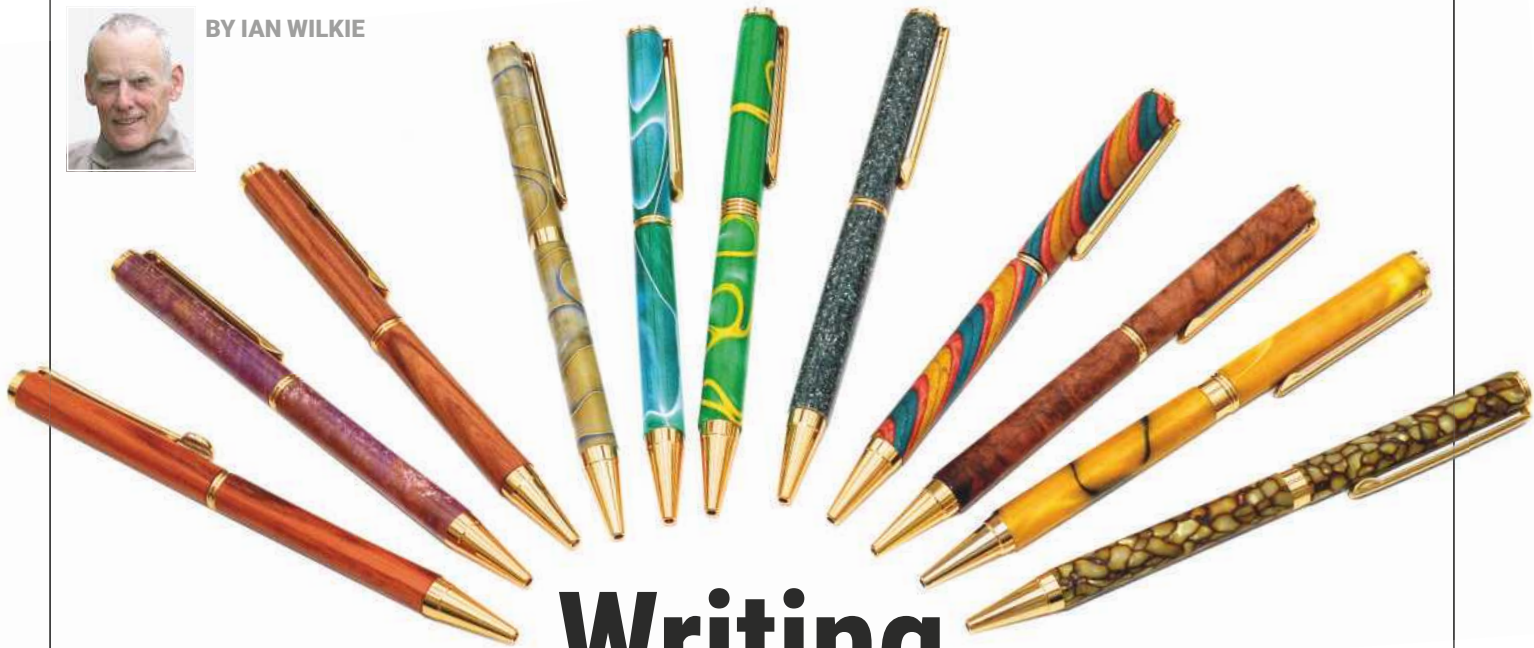

Writing with a flourish!

Why is pen turning so popular? It is probably because the turner can produce a very good looking pen in one turning session using basic equipment. The results are never the same so there is an element of surprise revealed with each pen blank. At the end of the operation, you are left with a very acceptable gift to give away or to sell at a craft fair.

In this article I will explain to those who have not made pens before the equipment required and I will run through the steps from start to finish to produce a basic 7mm twist ball-point pen. For those who are interested and would like to know more detailed information, I suggest you have a look at some of the many pen making videos that can be found online.

Ian Wilkie covers the broad subject of pen turning and discusses materials and equipment as well as showing you how to turn your very own 7mm twist ball-point pen



1 Wooden pen blanks are inexpensive, or you can make some up yourself using scraps



2 Laminated plywood pen blanks produce a very striking effect once turned



3 Acrylic pen blanks are very popular and there is a huge choice of different coloured varieties



4 A good starting point is to try the popular 7mm twist ball-point pen



5

The Charnwood W815 mini lathe is ideal for pen turning

Materials required

Most turners starting to make pens will choose a wooden blank (**photo 1**) and this is a good idea because you can afford to experiment without wasting money. You can either make up your own blanks – 150 x 20 x 20mm is the usual size – or you can purchase blanks already prepared in a number of interesting and exotic woods in mixed or individual wood packs. The wood does need to have character with striking colour and grain pattern to give impact.

Laminated plywood blanks (**photo 2**) are made from multi-layered colourful strips of timber, each approximately 1mm-thick and cut on a slight diagonal to give a pleasing and striking effect when turned. A pack of five costs £12.96 from Axminster Tools & Machinery.

It will probably not be long, however, before you move on to blanks made in plastic materials (**photo 3**) because there is such an enormous choice of vibrant colours and random, exciting patterns; no two pens are likely to look exactly the same. The term 'plastic materials' is used to cover acrylics, cast polyester resin, Inlace, Corian and other variations. I have found the acrylic blanks the easiest to turn and they can be purchased individually at £3-£4 each or a mixed pack of six costs £12.96. Acrylic turns well and takes a very high polish. The blank can look quite dull and plain at first but a transformation takes place when it is turned. Most of the blanks sold measure 150 x 20 x 20mm or 6 x ¾ x ¾in – Imperial sizes are often shown as many blanks are imported from the



6

A pen mandrel is used to turn most pen barrels and is adjustable in length



7

You will also need rapid epoxy resin or CA adhesive to secure the barrels in the blank

USA where pen making is hugely popular.

You will need to purchase a pen kit and a good starting point is to try the popular 7mm twist ball-point pen (**photo 4**), which is simple and at the lowest end of the price range. These kits are sold in packs containing all the parts you will need and a kit will cost about £4; usually there is a discount when

you buy a number of kits. A pen kit comprises: two tubes, clip, cap, nozzle, spacer, twist mechanism and a refill ball pen. If you take to pen turning you will probably go on to buy more elaborate fountain pens, biros or propelling pencil kits; some have only one turned barrel. There is plenty of choice and the price increases with complexity.



8 Micromesh abrasive is great for pen turning and the grits are handily identified using different colours

Equipment required

A pen turning mandrel will be required (**photo 6**). This consists of a MT holder (1 or 2MT to suit your lathe), a shank with spacers and a tightening screw. The end of the shank has a centre pop so that the mandrel can be supported with a revolving centre in the tailstock. This is a relatively simple device, which can be used to turn most pen barrels and is adjustable in length so that one or two barrels can be turned in the same operation. There are several makes to choose from and you can expect to pay in the region of £20 for a basic mandrel and above that for more sophisticated models.

The blanks need to be held and drilled

accurately and this is best done using a small bench drill with a machine vice to hold the blank vertically. A 7mm diameter twist drill is needed for the 7mm pen kit.

You will also need rapid epoxy resin or CA adhesive to secure the barrels in the blank (**photo 7**). A pen reamer is a useful accessory to clean up the ends of the blanks when the barrels have been glued in but a small disc sander will do the job just as well.

After turning the barrel you will need abrasives covering 240-600 grit (**photo 8**). For plastic materials, finer abrasives will be needed. Mixed packs of small Micromesh soft touch pads from 1,500-12,000 grit are sold for pen turning with the grits identified in different colours, which is very useful –

no rummaging through the box for the next grit. A box costs £10.96.

Various polishes (**photo 9**) are formulated to enhance the appearance of wood and to produce a high shine on plastic materials.

Most turning tool manufacturers produce a set of three tools in M2 HSS, which are designed and marketed specifically for pen turning. The set usually comprises a 12mm spindle roughing gouge, a 12mm skew chisel and a thin parting tool. I particularly like the Robert Sorby set of Modular Micro tools at £57; the skew is replaced in this set with a 12mm Spindle Master, which is an easier tool to use and sharpen and gives excellent results.



9 Various polishes are available, which enhance the appearance of wood and produce a high shine on plastic materials



10 The Robert Sorby set of Modular Micro tools is ideal for pen turning

How to turn a 7mm twist ball-point pen

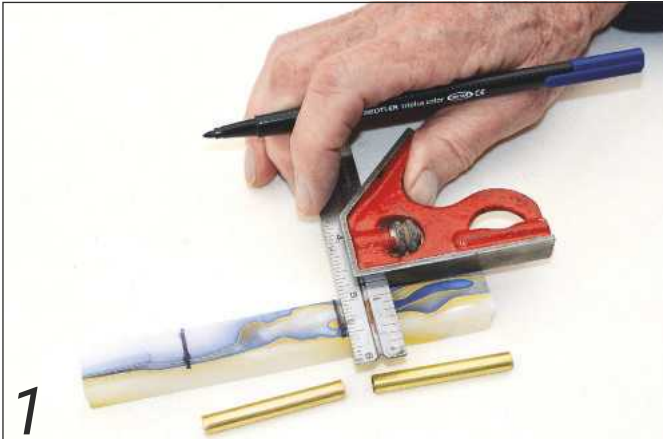

1 Mark a pen blank at the halfway point and cut through using a fine saw



Hold each blank in turn in the jaws of a chuck on the lathe. Fit a centre point drill in the tailstock and drill a shallow centre pop; this will ensure the drill bit locates accurately. You can go on to drill the 7mm hole with the blank still in the lathe, but I prefer to use a bench drill for this next operation



3 Fit a 7mm HSS twist drill in a bench drill. Set the depth stop to 55mm and with one half of the blank held vertically in a machine vice drill the hole for the pen tube; repeat for the second half of the blank. Check the depth with a piece of dowel marked at 55mm. Cut off the waste material so that you now have a blank with a hole drilled all the way through. If you drill right through in the first instance, there is always a risk of tear-out



4 Clean the outside of the tubes with fine abrasive to remove any grease

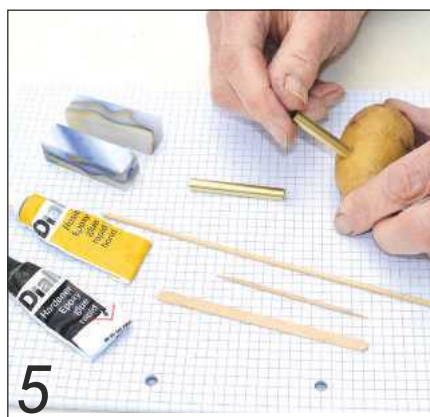

5 Temporarily plug one end of each tube (you can see a potato works very well!) Apply epoxy resin liberally to the inside of the holes drilled in the blanks and to the outside of the tubes, taking care not to get glue inside. Push the tube into the blank with a twisting action. After a few minutes, remove the potato plug with a piece of dowel and leave the adhesive to cure for approximately half an hour



6 Clean off any excess set glue at each end using a pen reamer. The reamer has a milling face, which helps to remove the wood or plastic to square up the ends, although I personally prefer to use a small disc sander for this operation



7
Fit the mandrel into the headstock and slip on the blanks and spacers. The pen mandrel will take one or two blanks and the 7mm diameter spacers are there as a guide. I prefer to turn one blank at a time but this is a matter of choice. The sequence is: spacer, first blank, spacer, second blank, spacer and then the tightening nut. Bring up the revolving centre to support the end of the mandrel

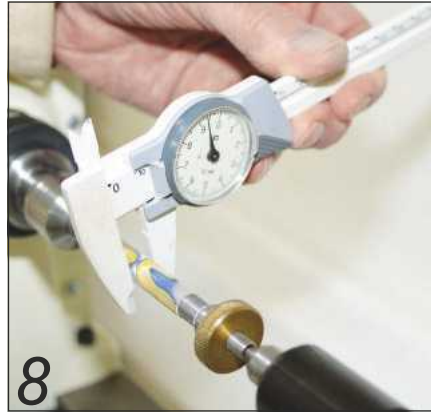

8
Set the lathe speed to 1,500rpm and using a sharp spindle roughing gouge, remove most of the material. Use the skew chisel to turn the final diameter just above the spacers. Here you need courage: take off too much material and you will be down to the tube; leave too much and you will have an unsightly step each side of the centre ring when the pen is assembled



9
Work through the abrasive grits to remove all turning marks and now the diameter of the barrels should match the 7mm spacer



10
Apply an appropriate polish for wood or plastic and buff up to achieve a high shine



11
Lay out the parts of the pen. Kits usually include a leaflet with basic instructions. Make sure you understand the sequence because it is almost impossible to disassemble the pen once the parts have been pushed together



12
Assemble carefully as shown in the photo. I have always managed quite satisfactorily using a bench vice to push the parts together; however, if I was making lots of pens I would consider purchasing a pen press

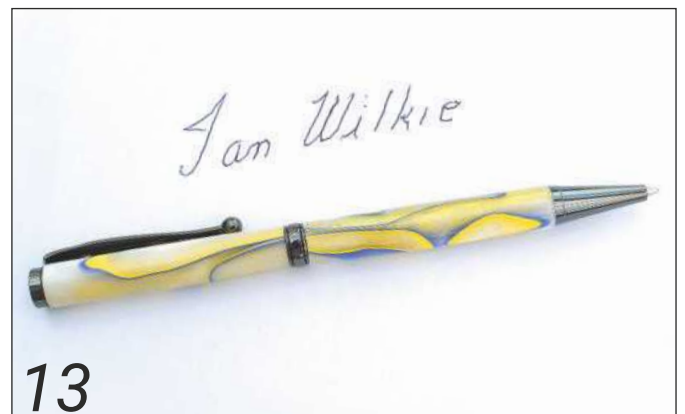

13
The finished pen. This kit has a gun-metal nozzle and clip; other choices can be chrome or gold

Assembly & display



The Axminster Deluxe Pen Assembly Press is a very well made, strong and sturdy piece of equipment



A wooden pen assembled using the pen press



Examples of more turned pens



Try making your own stand or box to display your turned pens

The Axminster Deluxe Pen Assembly Press (**see above**) costs £58.96. This is a very well made, strong and sturdy piece of equipment, which can be bench or wall-mounted. A nylon pad protects any plated parts of the pen body from damage while the toggle clamp applies an even pressure to press the part into position. The fast action thread adjustment allows you to quickly adjust the capacity to accommodate different sizes of pen kit.

After all that work, it seems a shame to put the pens away out of sight, so why not display them in stands or boxes (**left**). Presentation boxes are ideal for a pen given as a gift or can be purchased. Happy turning! [www](http://www.getwoodworking.com)

SUPPLIERS

There are many retailers selling all the equipment, pen kits and turning blanks you could possibly need. The four companies listed here all have good websites and you can send for catalogues to browse. There are many gadgets and additional pieces of equipment to tempt you but for the turner who is only going to make pens occasionally, you can keep it simple and not be led astray!

■ Axminster Tools & Machinery

■ 0800 371 822
■ www.axminster.co.uk

■ Charnwood

■ 01530 516 926
■ www.charnwood.net

■ Stiles & Bates

■ 01304 366 360
■ www.stilesandbates.co.uk

■ Turners Retreat & Craft Supplies

■ 01302 744 344
■ www.craft-supplies.co.uk

Stiles and Bates sell a start-up kit at £77, which represents good value although a bit short of the acrylic blanks. This would make a great gift for a turner who is new to pen turning. The kit comprises:

- No.2 Morse taper pen mandrel
- Pen mill tool
- 7mm drill bit
- Universal tube inserter
- 10 Slimline pen mechanisms
- Pen blanks – 10 wood; two acrylic acetate
- Epoxy resin glue (four minutes, 71g)
- Abrasives – 0.5m of 240, 320, 400 & 600 grit
- Instructions

NOW AVAILABLE IN THE UK **EXCLUSIVELY** FROM THE TURNER'S WORKSHOP

*Wholesale Inquiries Welcome



www.theturnersworkshop.co.uk
mail@theturnersworkshop.co.uk



Fast-Drying • Chemical & Impact Resistant • Easy To Apply • Low Odor
Non-Flammable • Water Cleanup • Can Be Applied While Turning • Low VOC

Welcome to
**THE TURNERS
WORKSHOP**
*The Company
with Traditional Values*

Our aim is to provide
quality items at a fair price.

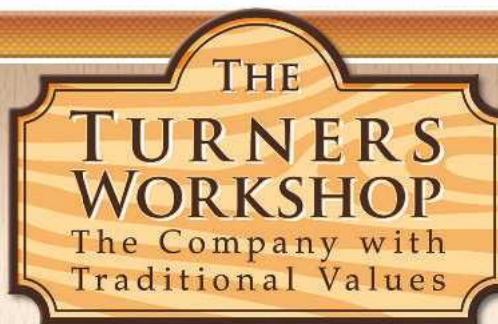

*In the hussle-bussle
and impersonal world we
live in today, I want to turn
back the clock and provide
a good old fashioned,
personal, professional and
friendly service to all my
customers.*

Vincent Coates - proprietor

- Pen Kits
- Woodturning Tools
- Abrasives • Adhesives
- Bushing Sets
- Finishing Products
- Books & DVDs
- Pen Making Accessories
- Workshop Furniture
- Knife Making Sets
- Turning Projects



*The Turners Workshop will appeal to all Woodturners, Pen Makers,
Pen Collectors, Craftsmen and Craft-ladies! Visit our comprehensive shop at:*

www.theturnersworkshop.co.uk • Tel: 07870 587615 • email: mail@theturnersworkshop.co.uk

WAREHOUSE/VISITING - UNIT 13, MORGAN BUSINESS PARK, MYLORD CRES,
CAMPERDOWN IND. EST, NEWCASTLE UPON TYNE, NE12 5UJ



Visitors by prior appointment to our warehouse

SHORT-BOARD



One of the pleasures of a holiday on the North Cornish coast has long been surfboard riding. Here, we revisit some constructional methods and techniques employed by fellow woodworkers sixty-odd years ago.

It's generally accepted that UK surfing properly began in the late 1920s, and some readers may well have seen archive home movie footage of Lewis Rosenberg taking his hand-made 8ft balsa board out into the Newquay surf in 1929. Intrepid types like Lewis have been fooling around on similar boards ever since, but it's only in the last 20 years or so that surfing has really taken off in this country.

Solid construction

Nowadays there are thousands of state-of-the-art boards to choose from, but back in the middle of the last century you had to

make your own if you wanted to take on the waves anywhere on our chilly coastline. This excerpt from *The Woodworker* of August 1953 shows a variety of methods for constructing the simplest of surf boards. Possibly taking a leaf out of Lewis' book, the first suggested course of action is to carve one out of a solid piece of balsa. This would be fine, but sourcing a suitably wide board is always going to be a problem, and it's unlikely many timber yards back in the '50s would have had much in stock. You never know, though, and certainly the would-be surfer is guaranteed maximum buoyancy with a solid board made of this particular soft hardwood timber.

Hollow boards

Handmade wooden surfboards these days are created hollow with thin ply formed over a pierced ply skeleton, and are really beautiful works of art in their own right. 60 odd years ago the acme of surfboard construction was a thin solid board with a turned up front to it, and the best way to achieve this would have been through lamination. With precious little good quality thin ply available at the time of this article, 3mm-thin solid birch or beech is the suggested material, with overboarded sandbags providing the pressure to ensure the glued-up laminate stayed pressed into a simple curved former and ultimately

BOARDS are of two general kinds; flat and curved. The former is very simple.

Flat Board.—Owing to its great buoyancy, balsa would appear to be ideal for this purpose, but, owing to its softness, it would not stand up to rough treatment on the beach. Another drawback is that it is not easy to obtain in the width required for a board, consequently two or more boards would have to be jointed together.

This does not mean that an unsatisfactory for a surfboard should certainly be used.

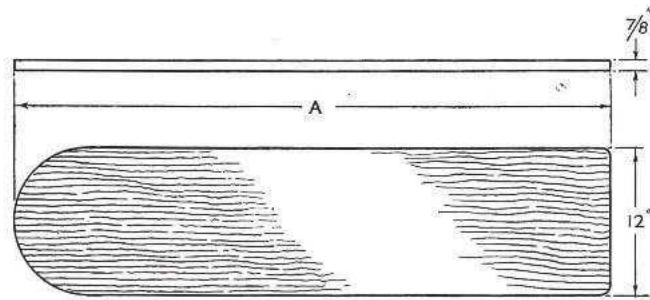

FIG. 1

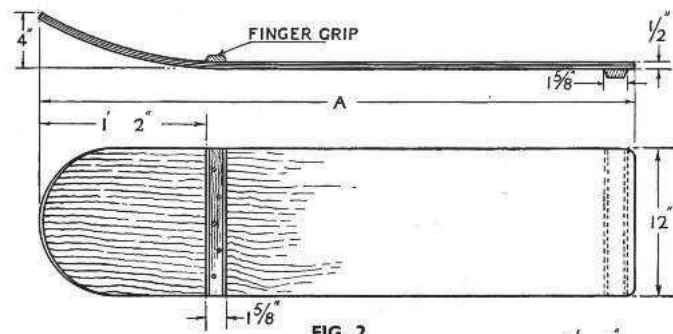

FIG. 2

$$A = \begin{matrix} 3' & 0'' \\ 4' & 0'' \\ 4' & 6'' \end{matrix}$$

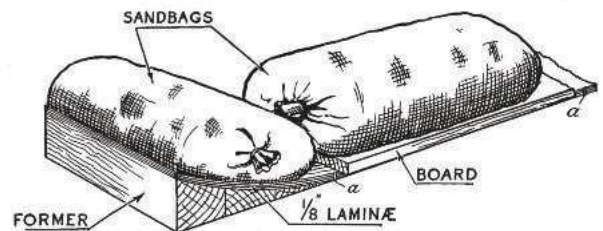

FIG. 3

FIG. 1. SIMPLE FLAT SURF BOARD MADE IN BALS A WOOD
FIG. 2. BENT AND LAMINATED BOARD
FIG. 3. HOW LAYERS OF LAMINATED BOARD ARE ASSEMBLED

AUGUST, 1953

158

SURF BOARD

at balsa would prove to be entirely of board. If it can be obtained, it will, of course, be understood that a waterproof synthetic glue would be necessary should it be required to glue two or more boards together to make up the width. A flat board is shown in Fig. 1 and various lengths are suggested to suit the height of the user.

Curved Laminated Board.—If thin wood can be obtained laminated construction makes a strong job. The best way is to build it up from laminae not more than $\frac{1}{8}$ in. thick as shown in Fig. 2. Birch or beech $\frac{1}{2}$ in. thick would be satisfactory and no trouble should be experienced in bending all the thicknesses to the desired curve. A suggested method of gluing the laminae together is shown in Fig. 3. The former for the curve is built up from pieces of deal glued together and the curve cut on a band saw if available. Alternatively, each piece can be ripped down prior to gluing so that it is roughly formed to the desired curve, the finishing being done with a round after the pieces are glued together.

The completed former is nailed on to a flat surface such as a bench top, and panel pins A are driven in so that they project slightly less than $\frac{1}{2}$ in. above the surface. These pins serve to locate the superimposed laminae. Four layers are required and the glue, which should be waterproof, is applied to one face of each of the sheets. They are then assembled on the former and pressed down with sandbags as shown. In order to obtain the necessary pressure, boards are cramped down over the sandbags.

When glue has set, the board is removed from the former and the front rounded and the edges cleaned up. The finger grip comprises a strip of hardwood screwed to the board, the heads of the screws being well counter-sunk. As the board scrapes on the sand after it has been carried in by a wave, a strip of wood is fixed at the rear of the board to take up the wear. It also helps to prevent the board curling in

its width. Ordinary plywood is not glued together with waterproof glue, therefore it tends to separate when submerged. If thin marine plywood put together with resin glue can be obtained this could be used. Two or more pieces (according to the thickness) could be put together with resin glue as in Fig. 3.

Alternative Kerfed Method.—If difficulty is experienced in ob-

One of the pleasures of a holiday on the North Cornish coast is surf board riding. Although surf boards can be hired, readers who propose to spend a holiday in this part of Britain may like to make their own. The only part of a board that may involve some difficulty is the slight upward curl towards the front, though this curve is not absolutely necessary. To anyone familiar with woodworking, the formation of this curve should not prove an insurmountable obstacle. One real difficulty may well be the obtaining of suitable material of the right size, in which case it would be better to purchase a board rather than to use material which would prove unsatisfactory.

taining thin wood, the upward bend can be formed by making a series of saw kerfs across the width of the board as shown in Fig. 4. There is no point in endeavouring to obtain a continuous curve right up to the front end of the board; it will be just as effective if the front portion is flat as indicated. It will be found that about seven kerfs made with a tenon saw and spaced $\frac{1}{2}$ in. apart and $\frac{5}{16}$ in. deep (assuming that the board is $\frac{3}{8}$ in. thick) will suffice to enable the bend to be made. In order to retain the curve, a piece of hardwood (A, Fig. 7) $\frac{3}{8}$ in. thick is inlaid into the face of the board in the region of the bend. The recess for this inlay should be made before bending.

Referring to Fig. 5, the surf board is clamped down on to a board by a pair of oppositely positioned clamps (B), the pressure being exerted through a transverse block (C) the lower surface of which has a slightly quicker curve than that of the bend of the surf board. The end (D) is then forced upwardly by hand. It may be found that the board, even though it has the saw kerfs, is too stiff to bend. If this happens to be the case, the difficulty can be overcome by pouring a kettle of boiling water over the part where the bend is to be made. When the end has been sufficiently raised, a block (E) is inserted and tapped in with a hammer until the front end of the surf board is about 4 in. above the level of the base board. When this has been done, a second pair of clamps (F) is applied. If it has been necessary to use boiling water, the whole should be allowed to dry since resin glue will not adhere to damp surfaces.

(Continued on page 145)

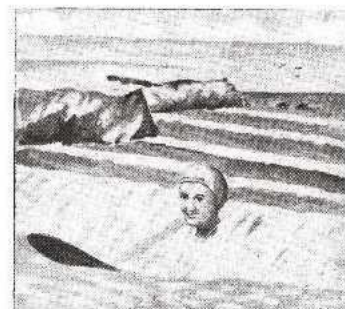

SOMETHING TO ADD TO THE ENJOYMENT OF YOUR HOLIDAY

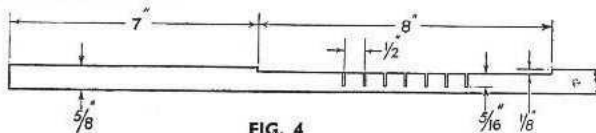

FIG. 4

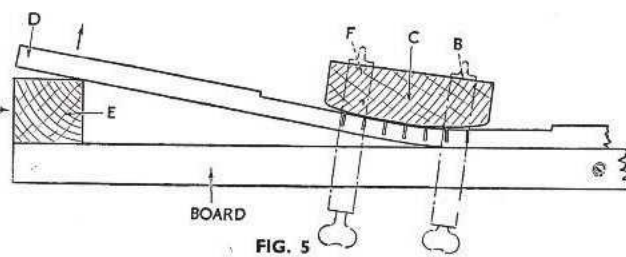

FIG. 5

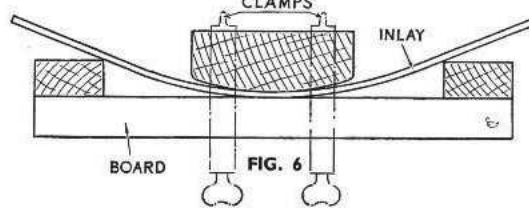

FIG. 6

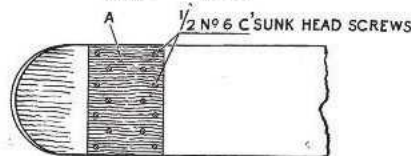

FIG. 7

CONSTRUCTION DETAILS OF KERFED SURF BOARD
 FIG. 4. Side elevation of board before bending
 FIG. 5. Method of bending: B tightened and F about to be tightened
 FIG. 6. How inlay or inset piece is bent before gluing
 FIG. 7. Plan of board showing position of screws

WOODWORKER

WOODWORKER

159

AUGUST, 1953

to achieve a successful job.

My own personal experience of this type of board was seeing a very battered specimen brought into the workshop years ago by a lady from Devon who's whole family had splashed and crashed about on it for decades. Looking at the drawings accompanying *The Woodworker* article published here, I'm pretty sure that hers would have been of that particular vintage and no doubt made by a *Woodworker*-reading friend or relative. My pal Steve and I set about making a replacement, using (I think), three or maybe four pieces of 4mm marine ply and Cascamite to achieve the laminated curved front. It came out

pretty well I remember, but these days the complexity of the clamping job would have been made much simpler by the use of a vacuum bag press.

The kerf method

Now, it's a well known fact that some woodworkers aren't too keen on lamination, and this must be the reason that the kerf method was included in the project instructions. I personally think that it's just asking for trouble, and a big dose of beach-side embarrassment, but, in theory, it ought to work out fine if executed with care and employing the most suitable adhesive (these days polyurethane (PU)

glue would give the maker the best chance of pulling the job off successfully). I don't think there are any other alternative ways of making a simple solid surfboard, but if anyone out there knows of one, please let us know!

By today's standards this little surfer is not much more than a body board, being only 3 or 4ft long or so, but you'd still be able to have fun on it and that's the main thing. As for impressing anyone watching, well, that's a different matter, but either way, it's a great example of making a practical item for yourself, and that surely is the underlying attraction of woodworking for all of us. [www](http://www.getwoodworking.com)



Picture perfect

Save money and make use of offcuts with a fine double-sided picture frame from Dominic Collings

I came up with this idea as a way to display my first piece of published woodworking writing, but photos of family and friends would work as well. Not wanting to have two frames to show four pages I decided to laminate the article between two sheets of glass, the idea being that you read one side, flip the frame around and read the other. This means that there can be no visible fixings on either side, which is a slight challenge, but once this is tackled there is great scope for variations in design.

Stock preparation

I have a 150mm planer, which means that I'm often left with a 25 or 50mm-wide strip when trimming down a 200mm board for machining. Similar stock is perfect for this sort of quick mini project.

With two lengths of stock planed to the same dimensions, most of the work will be done at the router table. The trick to the flip design is in the machining of the stock on the side where the glass will be rebated into. This needs to angle inwards rather than outwards at 45°, which is easiest to

achieve with a 45° 'V' groove bit. Set the fence of the router table so that the bit is visually in the centre of the stock. This is best done in several small passes raising the bit by a couple of millimetres at a time to a depth of around 5mm. If after the first pass it turns out that the bit isn't dead



Two lengths of stock were planed in preparation



The central 'V' groove of the frame was cut on a router table...

Ref	Item	QTY	Size	Material
A	Leg	30	63 x 68	OS white oak
B	Spindle - accent	18	70	OS white oak
C	Spindle - standard	18	61	OS white oak
D	Top rail	18	41	OS white oak
E	Bottom rail	18	57	OS white oak
F	Top plate	18	57	OS white oak
G	Bottom plate	18	96	OS white oak
H	Post	18	121	Walnut
J	Spine	4	10 x 10	1200 x 100
K	Buttress	18	254	914
L	Top - edge	18	70	914
M	Top - centre	18	29	787
N	Backcheck	12	273	342
O	File drawer - sides	12	382	387
R	File drawer - F & B	12	382	387
S	File drawer - bottom	12	342	342
T	File drawer - face	12	54	374
U	Panel drawer - sides	12	314	314
V	Panel drawer - bottom	12	348	348
W	Panel drawer - face	12	44	387
X	Drawer sides	18	44	457
Y	Drawer rearers	18	18	357
Z	Drawer rearers - cleats	18	18	357
AA	File drawer stop	10	18	413
AB	Panel drawer stop	10	18	413
AC				



3 ... as was the rebate, here using a featherboard for accuracy

centre, it's not too late to adjust this now.

With the bit dead central, without moving the fence, I installed a bit which corresponds to the thickness of both sheets of glass. This glass was 1.25mm-thick, so together that's 2.5mm, but the smallest bit I had was 3mm, which had to do. The pictures in the middle will take up some of this slack. It's a good idea to use a featherboard for this cut (**photo 3**).

The next bit is where you can make easy variations. In this case I stuck with the 'V' groove bit, setting the fence so that it created a chamfer, but you could use any radius rounding over bit or any angle of chamfer. With the chamfer on all sides of the frame both inner and outer, the result is an octagon shape. Now is a good time to do your sanding.

Cutting glass

For the glass I bought frameless clip frames, as this seems to be the cheapest option. I bought two A3-sized frames from a car boot sale for £2 but you can buy even larger sized ones from ASDA for as little as 69p each. It's often cheaper to buy a larger size and cut it down to custom fit your images, as this means that you are not limited to standard photo frame sizes. Cheap glass cutters can be bought for as little as £2.79, which work perfectly well on glass of this thickness.

I measured and marked a dot on the



7 After rough sawing, I used a belt sander to ensure I met the cut line accurately



4 Cutting the glass – use a set square here and a drop of oil also helps the glass cutter

glass with a chinagraph pen and with a set square as a guide scored the glass in one firm pass towards me. Expensive cutters are often oil filled but I find that a drop of three-in-one oil at the start of the cut works just fine so the cutter runs through it.

After scoring, turn the glass over and with the handle of the cutter give the glass light taps increasing in strength until a crack starts to form along the score line, then keep tapping along this fault line until it reaches the other side (**photo 5**). With the sections of frame fitted on opposing sides of the glass you can measure the width of the other sides.

All the pieces were cut on the mitre saw and sanded to the line on the stationary belt sander. Again, I didn't want visible fixings so framing staples to hold it together were out. Instead, I constructed a simple jig out of MDF and brads to hold the sections in a downward 'V' and ran them through a dovetail cutter on the router table. You could vary this by using a straight cutter to inlay one or two stripes if you prefer the look.

Finishing touches

I cut the dovetail keys vertically on the end of a board using the same cutter and cut to rough length on the bandsaw. With the pictures inserted the frame can be glued and clamped together. The dovetail keys do a good job of holding the mitres tightly



8 A dovetail jig was used on the router table to create the dovetail keys



5 Give the glass light taps until a crack begins to appear

together. When the glue is dry these should be cut with a flush trim saw and the joints given a final sand.

To hang the frame I measured the distance from the frame to the glass and planed a strip down to that thickness. This received a 45° chamfer to fit into the recess of the frame. Two screws were enough to attach it to the wall. The finish is my favoured Osmo Polyx Oil with a few extra coats of wax on top. **WWW**



6 Here you can see the glass frame on two opposing sides with tape measure between



9 Here I'm cutting the corner keys on the router table

Thomas Flinn & Co.

Saw & Hand Tool Manufacturer
Sheffield, England



The UK's last remaining traditional saw manufacturers.
**Now also manufacturing Clifton Planes
including a NEW Block Plane!**

Garlick
MADE IN SHEFFIELD
ESTABLISHED 1858

**E.T. ROBERTS
& LEE**

PAX
ESTABLISHED 1776

CLIFTON

www.flinn-garlick-saws.co.uk
orderonline@flinn-garlick-saws.co.uk
Tel: 0114 2725387

Bob Chapman is commissioned to make a standard lamp using an old mahogany table top

The enlightenment

When a good friend asked if I would make him a standard lamp from an old mahogany table top, of course I agreed. He assured me the table top was solid timber, not veneered MDF, and in due course it arrived – a deep red, rich mahogany which, as soon as I cut into it on the bandsaw, turned out to be an impostor – cleverly stained sapele (I think) masquerading as mahogany. This was a bit of a disappointment but better than finding it was MDF. Not at all downhearted, my friend happily accepted the difference in colour and still wanted to go ahead.

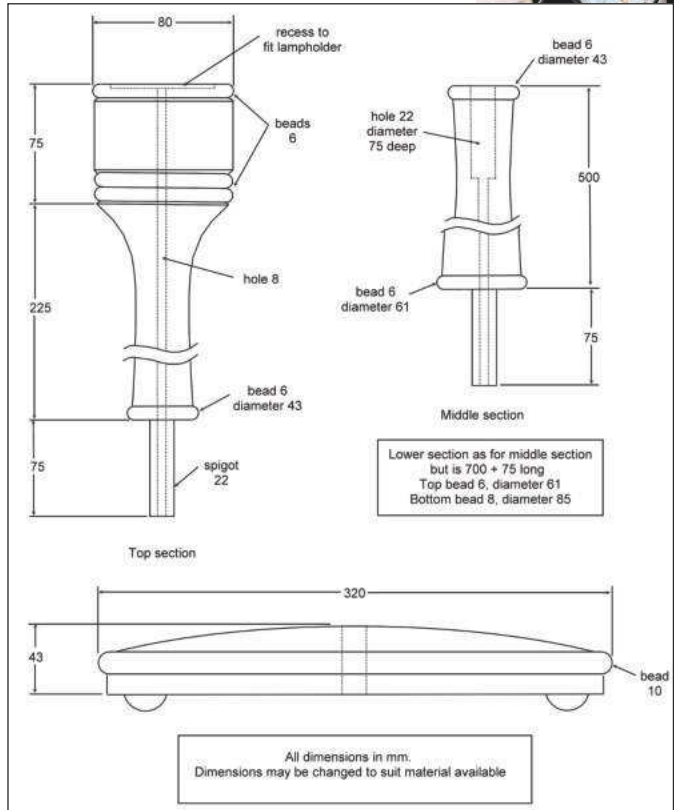

Fig.1 Measurements for the lamp (all in mm)



1 It pays to use a good quality glue



2 A ring centre cannot split the joint



3 Turn to round with a spindle roughing gouge

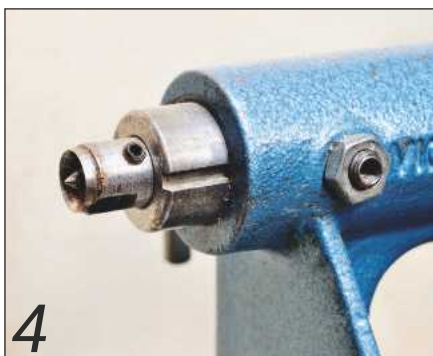

4 The hollow centre has a removable point...

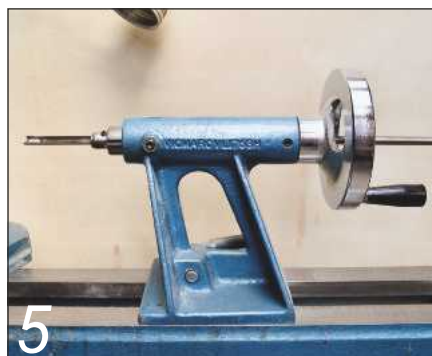

5 ... which allows the auger to pass through



6 Remove the point and centre on the ring mark



7 Feed the auger slowly and remove frequently

Gluing up

We then spent a little while arriving at a design that he liked and I thought would be feasible to make from the table top. The longest piece my lathe can accept is about a metre, so it was obvious that there would have to be joints somewhere, and we finally decided on three sections 300, 500 and 700mm long. Each of these would have to start life 75mm longer to allow material for the joints between them (Fig.1).

At 45mm-thick, the top was a hefty piece of timber but still not thick enough to accommodate a standard lamp, so the first step was to cut it into 90mm-wide strips. After planing one side of each strip, they were glued together in pairs to form blocks

90mm square – one for each section of the lamp (photo 1).

The danger in turning pieces glued together this way is that too much pressure from the tailstock may split the glue joint apart again. This can be avoided by firstly using a good quality glue, Titebond in this instance, and leaving it clamped securely overnight to give the glue time to cure properly. Secondly, instead of the usual pointed tailstock centre, a ring centre was used (photo 2). This applies even pressure to the end of the timber with no risk of the wedge action, which might cause the joint to split open. With the first piece mounted between centres, it was turned to round, giving a maximum diameter of about 87mm (photo 3).

Boring

The next step is to bore the long hole through it, which will take the wires up the lamp. To do this, the ring centre must be replaced by a hollow centre (photo 4), which at first sight resembles the ring centre but differs in two ways. First, the centre pin is removable, leaving a hole through the centre, and secondly this is a dead centre – it doesn't revolve with the work. When the hollow centre is fitted, the boring tool, called a 'shell auger', can pass through it and into the workpiece (photo 5).

With the centre pin in place the work can be centred on the hollow centre and enough pressure applied from the tailstock to leave an impression of the ring in the end of the workpiece. Then the pin is removed and the work supported just on the ring of the hollow centre (photo 6). Since this is a dead centre, it is wise to apply a little wax lubrication to the wood to prevent burning.

Turn the lathe speed down to around 750-1,000rpm to reduce heat generation, and begin to feed the auger through the tailstock and into the work (photo 7). Adjust the speed, if necessary, to give a smooth cut. Lubricating the auger with wax will help reduce friction and ease progress. Long hole boring is a slow process: push the auger forward no more than about 25mm before withdrawing it and clearing the swarf. Do not try to go further or the auger may wander offcentre. Lubricate

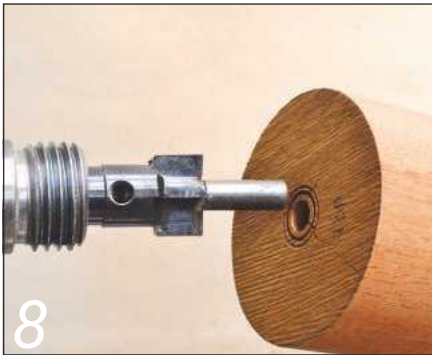

8
The counterbore drive



9
Using the bead-forming tool



10
Form a dovetail spigot to hold in the chuck



11
The steady rest supports the work



12
The top section finished

frequently and aim to go a little more than halfway through the workpiece.

Lamp fitting

Remove the workpiece from the lathe and replace the drive centre with a counter bore drive centre (**photo 8**); this ensures that the hole is maintained on centre. Repeat the boring process from the other end until the two holes meet in the middle. A shell auger, used carefully, is remarkably accurate and, surprising as it may seem, the holes do meet. My auger is 700mm long but once it is through the tailstock only about 450mm protrudes. This means the longest hole I can bore is about 850mm or so.

The hollow centre can now be replaced by a normal live centre with its point in the hole; this ensures that all subsequent work is concentric with the hole. Starting with the top section, the beads were cut with an Ashley Iles 6mm bead-forming tool, which ensures they are all exactly the same (**photo 9**).

My friend had purchased a speciality lamp fitting, which required a large diameter recess in the top and to cut this the work had to be held securely at the other end, so a dovetail spigot was formed with a skew chisel so that it could be held in a four-jaw chuck (**photo 10**). Even then it was still necessary to support the work with a steady rest to enable the

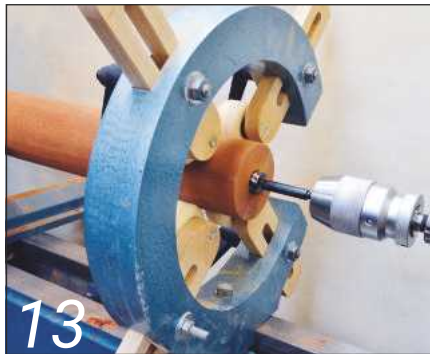

13
Use the steady again to drill the bigger hole



14
The beads side by side will hide the joint between them



15
Shape each section...

cutting of the recess (**photo 11**).

With the section again supported between centres, the shaping was finished, culminating in another 6mm bead and

a 22mm spigot, 75mm long (**photo 12**). This spigot would form the joint into the next section, and the joint would be disguised by the bead.



16 ... to blend in with the next



17 Wider sections glued for the base



18 Form the wider bead with a skew chisel



19 Skim the underside...



20 ... and add bun feet



21 Check that everything fits before gluing up



22 With the bulb and shade fitted...



23 ... the stand is finished

Shaping the sections

The next two sections were turned to round, and the central holes were bored just as in the first section, albeit a little longer. Held in the chuck and using the steady rest for support, each one had a 22mm hole drilled with a Forstner bit, 75mm deep to take the spigot from the previous section (photo 13).

With the sections back between centres, a 6mm bead was formed on the end, with a diameter to match the bottom bead of the previous section. This ensured that the joint would be 'lost' between the two beads when the sections were eventually glued together (photo 14).

Shaping of these sections then continued, removing the waste with a spindle roughing gouge and finally forming another 6mm bead and 22mm spigot, ready for the next joint (photo 15). Note that the lower bead on the bottom section has been increased to 8mm wide.

It is important that the main stem of the standard lamp appears to flow through the beads in a continuous slight curve and, to ensure this, the lathe was stopped

frequently to fit the sections together and check the flow of the curve (photo 16). At this stage, any of the sections can be re-mounted to make minor adjustments. When finished the sections were sanded to 400 grit, sealed and polished with Chestnut Products' Wood Wax 22.

Making the base

To make the lamp base two strips were glued together, avoiding the joints present in the original table top (photo 17). When the glue had cured thoroughly, a 330mm circle was cut out of the block and a faceplate was screwed on the underside, choosing screw positions that avoided driving screws into the glue joint.

The blank was trued up with a bowl gouge and a 22mm hole drilled all the way through the centre of the piece. The hole in the faceplate was large enough to allow this without damaging the Forstner bit. After shaping it to a smooth curve, the skew chisel was used to form a 10mm bead around the edge of the base (photo 18).

The base was sanded and polished and reversed onto pin jaws expanded

in the hole; this enabled the underside to be cleaned up with the bowl gouge (photo 19). The lathe's indexing system was used to drill three 10mm holes about 10mm deep, equally spaced around the base at about 50mm in from the edge. The base was finished by adding three small 'bun feet' (photo 20). I then reduced the length of the spigot on the lower section of the stand until it was flush with the base's underside.

Before finally gluing the sections together, they were dry fitted together and placed on a flat surface to make sure the lamp stood steadily and was vertical (photo 21). With everything looking good, the sections were all glued together and left overnight for the glue to cure.

Wiring

Wiring a lamp is not a difficult task, but if you are in any doubt about doing it yourself, do the sensible thing and get a qualified electrician to do it for you. The addition of a lamp bulb, in this case a retro-style Edison lamp, and a shade completes the job (photo 22). The finished standard lamp now takes pride of place in its new home (photo 23). [www](http://www.getwoodworking.com)



Woodsmith

Tools, Books & Devices for Traditional Woodcraft



www.woodsmithexperience.co.uk

Discover.Experience.Shop

George Foweraker

Woodturning Lessons in Somerset



One to one tuition with a Registered Professional Turner
Maximum of two students

Beginners courses available or tailored to your needs

Telephone: 01278 782074

www.Artistry-in-wood.co.uk



www.routercutter.co.uk

your online mechanism for resourcing quality tooling
specializing in 'industrial grade savvy'

Contact

Website: <https://routercutter.co.uk>

Email: sales@routercutter.co.uk

Office address: ROUTERCUTTER.CO.UK

South Point / Old Brighton Road
Lowfield Heath / Crawley
West Sussex / RH11 0PR / UK

Our online stocks are genuine and all goods are mailed from the UK. Whiteside have been manufacturing quality industrial grade router bits for more than 30 years. Proudly made in North Carolina USA. Router bits designed & engineered for the Woodworker.

We now also stock Southeast Tool Inc. router bits and accessories. Tools from the smiley people. Made in USA.



IN STOCK NOW:

The "ULTIMATE"

PATTERN & FLUSH TRIM BITS 2+2 Compression Technology

Bearing guided for every workshop

UDP9112 Pattern Bit

UDFT9112 Flush Trim Bit

UDC9112 Combination Bit

by WHITESIDE

ALSO NOW IN STOCK:

2 flute spiral bits with metric "D"

1/4" shank, 5mm cutting diameter

1/4" shank, 6mm cutting diameter

1/2" shank, 8mm cutting diameter

1/2" shank, 10mm cutting diameter

1/2" shank, 12mm cutting diameter

Custom made in the USA by WHITESIDE

Special price on WHITESIDE RD5200A

1/2" shank, down cut spiral

D = 12mm; c/l = 50.8mm; o/a = 101.6mm

GBP 35.00 per piece



WHITESIDE MACHINE COMPANY

Nominated in both categories by Fine Woodworking Magazine June 2007 - in an 18 bit road-test evaluation

Author's Choice - BEST OVERALL / Author's Choice - BEST VALUE

SCROLLSAWING

a beginners' guide

Examples of Roger's work with the scrollsaw

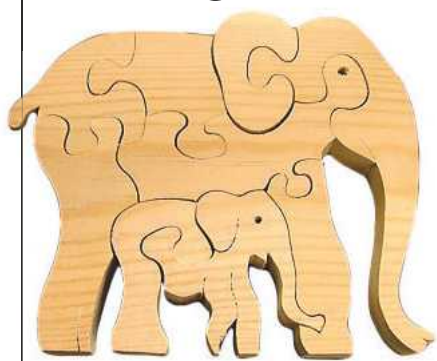

Roger Berwick, professional carpenter and woodworking expert at Hochanda, reveals six important things for you to consider if you're looking to take up scrollsawing

Scrollsawing is a wonderful hobby for all woodworkers, and the versatility of the scrollsaw is what makes it such an enjoyable tool to use. But while the scrollsaw is one of the safest woodworking power tools, it must still be treated with care and respect – and your personal safety is key!

Choosing the right scrollsaw

There are many scrollsaws on the market but you need to consider the saw that is best suited to what you want to do with it. Opt for a machine that will accept both pinned blades as well as pinless blades (the latter being used for extremely fine work). Also, look for an air blower that will remove the sawdust from the blade as this will give you good visibility of the cutting line. Single speed machines are OK, but a variable-speed unit will give you far more versatility and a 406mm throat or larger behind the blade will allow larger items to be cut with ease.

Choosing the right location

The scrollsaw will vibrate during use, so you will not want your bench or table wobbling under the saw. For this reason you will need to mount your scrollsaw on a suitable bench or work surface that is sturdy in its construction. It's also important to consider the height of the bench – do not have it so low that you are bending over the saw. You could be using it for extended periods of time, which could lead to you developing back ache.

Choosing the right blade

There is a plethora of different scrollsaw blades on the market, with pinless blades for the finest of cuts and

heavier pinned blades for deeper cuts in thicker material. Initially I would suggest that you buy a selection pack of blades so that you have a variety to try, and from there you can buy just the ones that you find yourself using most. If you are using your scrollsaw to cut plastics/non-ferrous metals, etc., make sure that you source the appropriate blade for your material requirement.

Setting up your saw correctly

Is the table at 90° to the blade? Are the table adjustment knobs tight? Is the dust blower positioned correctly? If not, using a scrollsaw can be dangerous and could also impact the quality of your woodwork, so check all of these before you begin.

Also, make sure that the blade is tensioned correctly – it should make a sharp 'ting' noise when plucked but not flex more than 3mm when pushed sideways. The blades will break from time to time, but if over or under tightened they will break much more often. Remember – a well set up saw with the correct blade will cut with ease.

Take your time

When making your cuts let the saw and the blade do the work: all you are doing is guiding the workpiece. If you are finding the cut is hard going, you may need to adjust the cutting speed or the blade type in use. To achieve the best cuts, remember to keep

the workpiece moving forward smoothly to get the best curves, as jerky movements will result in a disappointing cut. It really does pay to take your time here.

Be safe

Make sure that you wear safety goggles or glasses and keep your fingers well away from the cutting blade. Also consider the dust being generated and wear a mask or apply an extraction vacuum source. **WW**

SCROLLSAW SUPPLIERS

■ Axminster Tools & Machinery

■ 0800 371 822
■ www.axminster.co.uk

■ Einhell

■ 01516 491 500
■ www.einhell-uk.co.uk

■ Hegner

■ 08455 670 001
■ www.hegner.co.uk

■ NMA Agencies

■ 01484 400 488
■ www.nmatools.co.uk

■ Record Power

■ 01246 571 020
■ www.recordpower.co.uk

■ Sealey

■ 01284 757 500
■ www.sealey.co.uk

■ SIP

■ enquiries@sipuk.co.uk
■ www.sipuk.co.uk

FURTHER INFORMATION

Inspired to learn a new hobby or skill?
Tune into Hochanda on Sky 663, Freeview 39,
Freesat 817, or visit www.hochanda.com

DIGITAL
SUBSCRIPTIONS
AVAILABLE ONLINE!

Receive a **FREE** Wixey Mini Digital Height Gauge WR25*

when you subscribe today

WORTH £25.00

**"A great addition
to your tool box!"**



The Wixey WR25 Mini Digital Height Gauge is a light weight, easy to use gauge for all types of woodworking applications.

Key Features:

- The Wixey Mini Digital Height Gauge with fractions - can be used to set saw blade and router bit height. As well as set the distance from the router fence to the bit
- The large easy to read LCD - will display in mm and when in imperial will display decimal inches and the inch fractions
- The fractions will only display when the decimal reading is within + or - .002inch of the fractions decimal equivalent



- Range - 76mm (3.0inch)
- Fraction - 1/32, Metric - 0.05mm
- Base Width - 110mm (center gap 60mm)
- LCD Display - 10mm character
- Auto Shut off - 30-60 minutes

TERMS & CONDITIONS: Offer ends 8th July 2016.

*Gift for UK subscribers only, while stocks last. Please note that our customer service agents cannot confirm whether you will receive a gift at the point of ordering your subscription - gifts will be issued on a first come, first served basis. The publisher will not supply an alternative gift in the event of our gift stock being exhausted. **This digital discount is only available when you subscribe to the print + digital package. You can still get a great discount on the digital package, please visit the URL stated above for more information. Please see www.mytimemedia.co.uk/terms for full terms & conditions.

SUBSCRIBE SECURELY ONLINE

<http://tww.secureorder.co.uk/TWW/V916>

CALL OUR ORDER LINE

0344 243 9023

Lines open Mon - Fri - 8.00am - 8.00pm GMT & Sat - 9.30am - 3.30pm GMT

Quote ref: V916

Calls are charged at the same rate as standard UK landlines and are included as part of any inclusive or free minutes allowances. There are no additional charges with this number. Overseas calls will cost more.



Pips & Cores

Don't let those apples go to waste, says Michael Pooley – celebrate our national fruit by building a cider press



Summer is almost upon us and so our streets are steadily colouring red and green – the comforting sign of apple trees heavy with nearly ripe fruit. Those of you blessed with an apple tree in the garden, though, must find it rather a nuisance disposing of all of those surplus apples come autumn. Why not put them to good use as delicious juice or conversion into cider? All it takes is a little woodworking know-how to make a fun and useful cider press, as I have done.

Mine's large enough to be used at community events; it's easily portable by four people and will sit comfortably in a

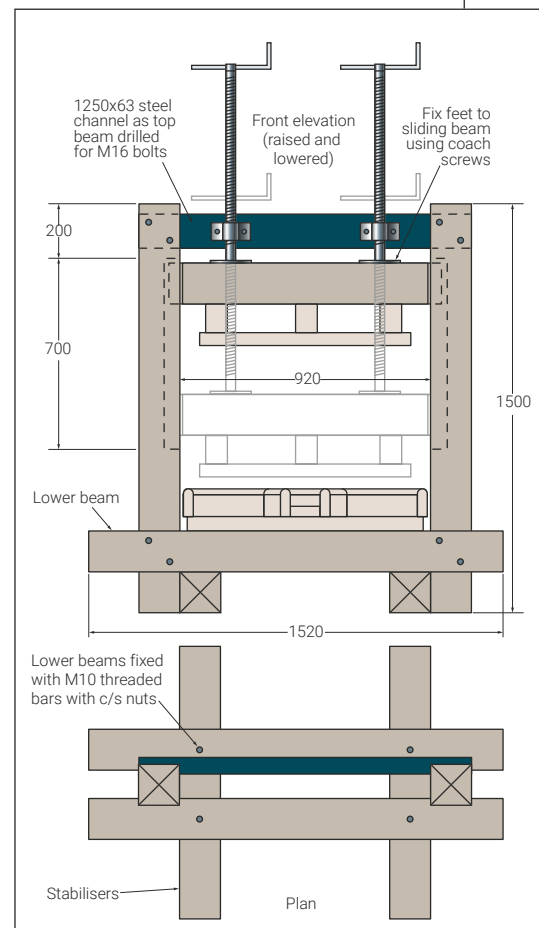

trailer or a pick-up, but there's no reason why you can't scale it down a bit. The real beauty of the press is that it's good-looking and capable of producing juice in volume, and it also uses modern jacks or prop stands (readily available from large farm machinery suppliers) for the screw mechanism, dispensing with the need to hunt down old screw mechanisms from derelict presses in salvage merchants.

While this type of press is enjoyable to build, there are many skills to be acquired along the way, too. The equipment is robust, satisfyingly transparent in its working, requires no independent power supply and, above all, encourages group participation in use. What better way to celebrate our national fruit?

Materials you'll need

I used British green oak for the main beams of the press and offcuts of green or seasoned ash laths for the cheese racks, which separate the cloth-bound layers of pulp. The juice tray or chuter, on the other hand, needs to be made out of seasoned timber because it has to be juice tight. Oak is ideal but ash, beech or sycamore are good alternatives, depending on availability. The cheese

frame, used to define and build up the layers of apple pulp, can simply be made out of any hard or softwood offcuts.

Fixings should be galvanised or sheradised coach screws, and bolts and threaded bars where specified, as iron reacts particularly with the tannin in oak (especially green oak) causing unsightly staining. On the other hand, any possible contact between the protective zinc and apple juice should be avoided (zinc being poisonous) – use aluminium or stainless steel fixings instead. In practice, the only instance where this applies is in the ash-lath cheese rack; stainless steel rivets, pins or screws should be used.

The mild steel (MS) channel used as the top beam and any other exposed metal subject to rust should be protected with a good quality black metal paint. The open screw jacks or prop stands are usually supplied already metal protected, though in time they may need to be painted. Do not paint the threaded sections of these jacks, but keep them well greased.

Although this type of press can be transported without too much difficulty, bear in mind that you are still working with pretty substantial timbers. It's best to fix sections together only at the appropriate stage.

Preparing the timber

From your stock of green oak cut the seven main sections of timber. As you'll see from the photos, there are two stabilisers, each 1m x 150mm square; one sliding beam 1m x 150mm square; two lower beams, each 1.5m x 150mm square; and two upright posts, 1.5m x 150mm square.

Lay the two stabilisers roughly parallel to each other, 1m apart, and lay the lower beams across the stabilisers for ease of working. Cut 20mm-deep checks at 150mm from either end of each beam to make a tight fit with the posts. Do not fix the beams together at this stage.

Using a chain mortiser – or drill and chisel – cut out the long channel for each upright post, 700 x 60 x 60mm. These channels will accommodate the tenons of the sliding beam.

Finally, cut out the checks in the top of the posts to take the MS channel beam. The depth of the checks should be such that the threaded jacks when bolted are centralised with respect to the sliding beam.

The timber arrises of the posts and lower beams can now be cleaned up for safety and appearance with a router, though if you find it more convenient, you can leave this until after you've assembled the press.

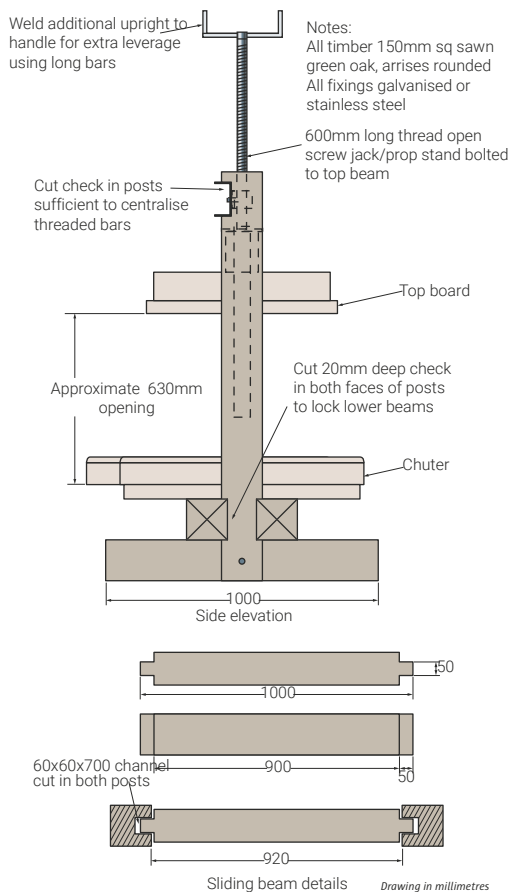

1 The press comprises two stabilisers, one sliding beam, two lower beams and two upright posts



2 Lay the two stabilisers roughly parallel, 1m apart, and lay the lower beams on top



3 Cut checks at either end of each beam to make a tight fit with the posts



4 I used a chain mortiser to cut out the long channels in each upright post...



5 ... these channels will accommodate the tenons of the sliding beam



6 The timber arrises of the posts and lower beams can be cleaned up with a router

Cut tenons 50mm square at either end of what will become the sliding beam, and chamfer each one. Because this is a loose fit, you can locate the beam after the posts and the other timbers have been permanently fixed; by offering the sliding beam up at an angle, it can be located in its channels and removed easily as necessary.

Assembling & fixing

You are now in a position to fix the stabilisers, lower beams, and posts together. Chock up the stabilisers on deep chocks – enough to be able to drill through and work on the undersides – then lay the lower beams into position and lock in the upright posts. After this, square up and level all of the timbers ready for fixing.

Drill a centred single hole right through and fix the lower beams to the stabilisers with an M10 threaded bar, countersunk and cut flush, and then tighten the nuts securely above and below. Do the same for fixing the posts to the stabilisers, before finally drilling and fixing the lower beams to the posts by the use of two M10 threaded bars per post, once again countersunk and cut off flush.

The channel beam

A metal workshop or steel stockholder will supply you with the necessary channel cut to size; it should be a standard 125 x 63mm channel cut to 120mm. Alternatively, any suitable channel of the same length would serve but must fit snugly in the checks made in the posts. Using a bench drill, you will need to drill through the beam for fixings to the posts and two further



7 Drill and fix the lower beams to the posts with M10 threaded bars

sets of drillings to take the threaded clamps for the open screw jacks.

Drill two sets of holes at either end of the channel to take M16 bolts for fixing to the two posts. At the same time, drill two sets of holes to take the threaded clamps, each centred 360mm from either end of the channel.

Finally, if the swivel feet of the screw jacks are not already pre-drilled, then two 8mm holes need to be drilled opposite to each other for simple screwing down to the sliding beam. Now offer up the steel channel beam and mark the posts for drilling, before removing the channel and drilling the posts. Fix the steel channel beam in place with M16 bolts, washers and nuts, then tighten securely.



8 As it's a loose fit, the sliding beam can be fitted at an angle after fixing the other timbers

Engaging the screw jacks

Locate the sliding beam in place by manoeuvring at an angle, then bolt the screw jack clamps to the steel channel, engaging the screw jacks and thread right down so that the feet sit on the sliding beam. Now using galvanised coach screws, fix the swivel feet of the jacks to the upper surface of the sliding beam.

Note that, in operation, once the jack handles have been turned down as far as they will go by hand, it will be necessary to continue pressing using long timber poles as levers. To this end you will need to get your friendly metalsmith to weld on a further upright to each handle to make what is essentially a two-handled jack. You may wish to get this done before fixing



Drill two sets of holes into the steel channel beam for the bolts that will fix it to the posts



Fit the channel beam in place and tighten the screws securely



Using galvanised coach screws, fix the swivel feet of the jacks to the sliding beam

your jacks to the steel channel. The main body of the press should now be complete and looking rather splendid!

The juice tray

The overall dimensions of the juice tray or chuter should be 900mm square. Use kiln-dried or other seasoned oak in slats of 30mm thickness but of such width (variable if necessary) as can be got hold of – about enough to make the base layer – then make another layer 820mm square on top of the base layer in the opposite sense for strength and minimising juice leakage. Notice that one or two of the centrally positioned slats will need to be longer and lip-shaped to form the juice spout.



The cheese racks lock the package of apple pulp in place and provide drainage

Now fix both layers together using screws from the underside, ensuring that the slats remain as tightly abutted during the process. With time the seams will open a little anyway, but traditionally, cider press juice trays were always a little leaky without representing any real problem.

Now cut 40mm-thick seasoned sections to form the walls of the juice tray. Use a little wood glue and fix with screws from the outside and underside. The overall depth of the tray (including base thickness) should be about 150mm. Give the edges of the walls a 15mm chamfer to complete the tray.

A locking bar 900 × 100 × 50mm should be fixed centrally to the underside of the juice tray to engage between the press' lower beams when in position.

Cheese racks

For a press of this size you will probably need to make half a dozen of these racks (they can be bought in acacia hardwood); they're a bit time consuming to make, but will last for years. Each time a layer of apple pulp is built up and the cloths folded over, one of these racks is placed on top to lock the package of apple pulp in place and provide drainage through the cheese.

The overall dimensions of each rack should be about 600mm square. Cut out green ash laths of nominal 25 × 6mm. Alternatively, you can use any good hardwood timber of your choice, green or seasoned. You will need 20 lengths per rack fixed at approximately 60mm centres with either stainless steel rivets, pins or stainless steel screws.

Cheese frame

A press cloth is loosely fitted into this open box and apple pulp is piled in up to around 50mm, pushed well down into the corners to make a neat layer, before the cloth is folded over and a rack placed on top. The frame is then pulled up and two long laths fed through slots in the frame. The laths rest on the rack of the layer below and in this way the frame is ready to take the next cloth and layer of apple pulp. The frame is thus the means by which the cheese is well defined and stable, and sets the depth of apple pulp.

Make this simple frame using any softwood or hardwood offcuts, nominal 150 × 25mm sides, internal dimensions 620mm square × 150mm deep. Nail or fix with galvanised or stainless steel screws into timber fixing blocks on the inside corners of the frame. On two opposite sides, cut two narrow slots per side to take two 1m-length softwood or hardwood slats for use when building up the cheese.

Top board

This is the final piece of heavy boarding, which goes on top of the cheese, spreading and transferring the pressure applied to the apple pulp as the top beam is brought down. Make this top board out of planed green oak. The overall dimensions are 700mm square using nominal 100 × 50mm slats. To strengthen and give depth to the board there are three cross beams, 100 × 150 × 650mm, which are fixed from the underside using galvanised steel drive screws, countersunk and plugged since they can come into contact with the juice.

Two baulks of oak timber, nominally 650 × 150mm square, will be needed as packing pieces and these will be placed on the top



13

The cheese frame is the means by which the cheese is well defined and stable

JUICY TIPS

The apples need to be sound and ripe – bruising is acceptable but discard mouldy fruit without compromise – as well as washed and milled into a fine state before loading this pulp into the press. Traditionally, the apples were milled by use of a ‘scratter’ but many amateur cidemakers these days make use of garden shredders with a sloping outlet. There are dedicated food-grade stainless steel scratters or milling machines available, which are preferable, although they come at a price. The milled apple is layered in nylon or synthetic cloths, separated by wooden drainage racks, to build up a ‘cheese’. It is this that the moving beam presses down on, releasing anything between 20-30 gallons of juice at a time depending on the height of the cheese. The press being discussed here will produce about 10 gallons at a single pressing. Historically, the juice would have been fermented to cider but nowadays, many people prefer to drink at least some of the juice, which is delicious and wholesome and can also be conveniently frozen or pasteurised for year-round supplies



You might not want to make a press quite as large as mine!

PULP FICTION

If you would like to know more about techniques for fermenting apple juice to different ciders or how to preserve it for year-long supplies, without any loss of flavour, or a host of other uses for such juice, then *Real Cidermaking On A Small Scale* by Michael Pooley and John Lomax might be of interest to you. Published by Special Interest Model Books, 136 pages, 60 illustrations and photographs, ISBN 978-1-85486-195-5, £6.95 – see www.amazon.co.uk

board just prior to pressing the cheese of apple pulp.

Moving the press

The simplest arrangement for moving a press of this size is to fix a metal bracket onto the outside face of each upright post and then feed through two wooden carrying poles, approximately 1.5m x 75 x 50mm – these can be used as lever poles once hand-pressing has finished. Of course, you might not want to make such a large press as mine! www.woodworking.com

Good Woodworking

BECOME PART OF THE ONLINE COMMUNITY FOR GOOD WOODWORKING MAGAZINE

Get access to exclusive competitions and giveaways

Exclusive articles and advice from leading professionals

Join our forum and make your views count

Sign up to receive our monthly newsletter

Subscribe and get additional content including Online Archives dating back to 2007*

Register for free today and join our friendly community!

*only available with digital or print + digital subscriptions

WWW.GETWOODWORKING.COM



FOLLOW US



GET INSPIRED



DRILL. DRIVE. DONE.

With the Kreg® Deck Jig™ and a few simple tools you already own, you can create a beautiful and functional deck surface that is completely free of exposed fasteners and painful splinters.

Spacer rings for accurate board spacing

3 drill guides for installing boards in restricted spaces



Find your nearest stockist
kregtool.eu



NO ONE EVER REGRETTED BUYING QUALITY

Professional 440

- Manufactured in Italy to a build quality you would expect from a genuine European manufacturer
- Italian motor 100% duty cycle
- German braking system
- Solid cast wheels not spoked
- Bonded rubber not stretch over
- Easy blade change
- Rack table tilt



Specification:

Wheel diameter.....440 mm
cutting width.....420 mm
cutting height.....280 mm
motor power.....1.5 hp
dimension.....810 x 660 x 1910

£1695 plus vat (total £2034 inclusive)



Unit 15, Pier Approach Road Industrial Estate, Gillingham, Kent ME7 1RZ
tel: 01634 572625 • www.acmukbandsaws.co.uk





Ciarán Ó Braonáin
CUSTOM WOODWORKING

Woodwork courses



Learn basic woodworking skills and make
a piece of hand crafted hardwood
furniture to take home

All wood and quality hand tools will be provided.
To find out more information on courses please visit my website at

www.obraonainwoodworking.co.uk

Book Now
Limited spaces

Castle Park
Arts
Centre
Frodsham

For any other queries please contact
Ciarán on 07768 076990
ciaran@obraonainwoodworking.co.uk
www.obraonainwoodworking.co.uk



New Anglia Tool Centre showroom in Oxford

Anglia Tool Centre's newest showroom recently opened in Oxford, featuring an exciting range of products from leading power tool brands including Makita, Dewalt, Milwaukee, Festool, Trend and many more.

If you're in the area, join the many local tradesmen and woodworkers benefiting from the new Anglia Tool Centre showroom, located on Peterley Road just off the eastern bypass of Oxford.

Alternatively, visit their website: www.angliatoolcentre.co.uk to find your nearest showroom.

A unique power tool offering

At Anglia Tool Centre, customers can

benefit from using their in-store demonstration areas, where customers are able to try power tools before buying. Each product is price matched with their website, meaning you always get the best prices available.

If you prefer to shop online, Anglia Tool Centre also provide a convenient click and collect service, so you can collect your order at one of their many showrooms.

Visit them in store where their friendly and knowledgeable staff can provide expert advice on finding the right tool for the job.

Open weekdays: 08:00-17:00
and Saturdays: 08:00-12:00.



**Anglia Tool Centre,
24 Peterley Road, Oxford OX4 2TZ**

Tel: 01865 777066 Fax: 01223 498729

Email: sales@angliatoolcentre.co.uk

www.angliatoolcentre.co.uk

Steve Giles RPT

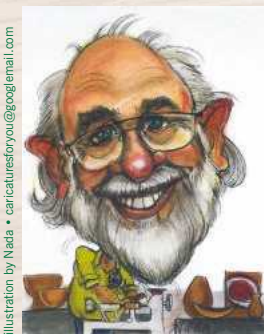

Illustration by Nada • caricaturesforyou@googlemail.com

Woodturning Courses in West Berkshire

Woodturning courses are structured to suit the beginner or more advanced turner.

Courses are offered on a one-to-one basis usually although courses for more people can be arranged on request.

Gift vouchers are available.

I am happy to discuss commissions for production work of various types and able to specialise in short run bespoke work. This includes furniture components, architectural items together with restoration projects.

My work ranges from functional bowls to decorative sculptural pieces and wall hangings.

Please phone or email with enquiries.

01635 45930 or 07760 123294
info@stevegileswoodturning.co.uk
www.stevegileswoodturning.co.uk

Woodturning
Commissions • Tuition
Architectural & Bespoke projects



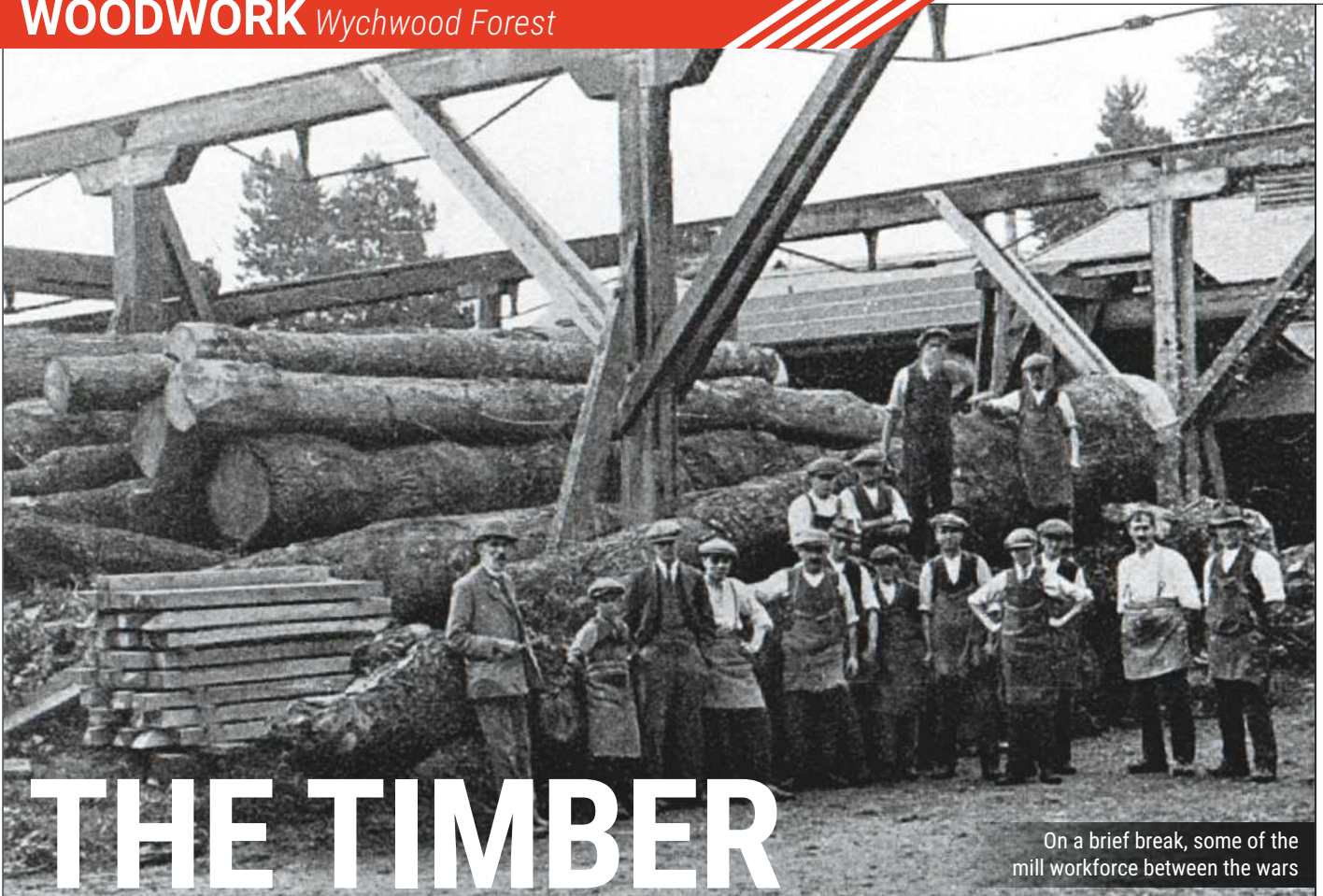

On a brief break, some of the mill workforce between the wars

THE TIMBER in the Wychwoods

Derek Willis examines the historical significance of the Wychwood Forest area, how this has changed over the years, and how many are working to protect its conservation and legacy

Near Oxford, the three villages of the Wychwoods (so called because they were originally populated by the early Iron Age Hwicce tribe) are known as Ascott-under Wychwood, Shipton-under-Wychwood and Milton-under-Wychwood. These villages were once in or around the Wychwood Forest, a wild forest consisting of dense woodland and coppices, with grazing and agricultural land all contained within the trees, with wild clumps of standing timber scattered everywhere.

Wychwood was a Royal forest, used by the King and his followers for sport, and especially the hunting of deer which abounded back then. Today, the remains of the forest are now concentrated around the village of Leaffield, a few miles from the Wychwood villages (see map above right).

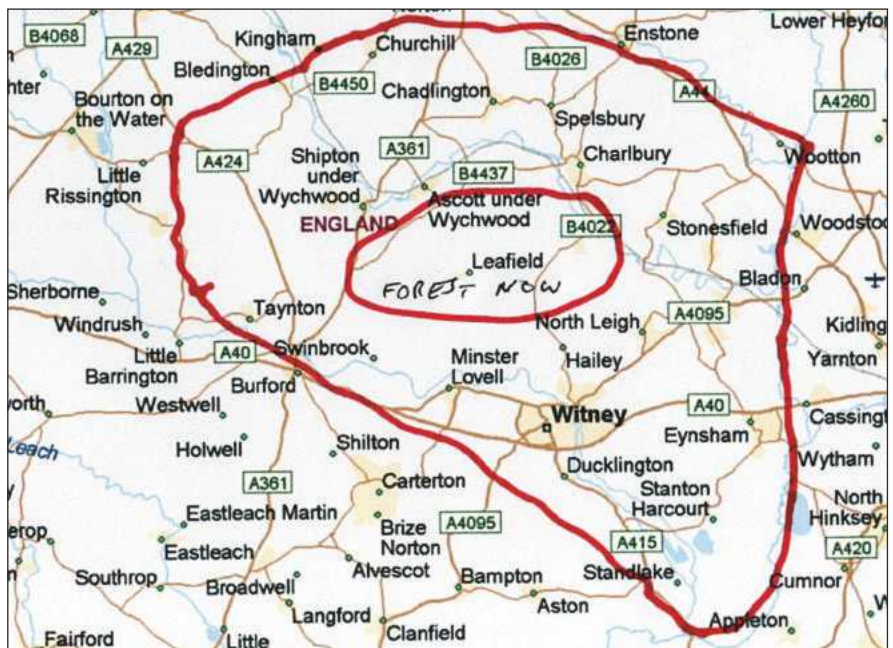

The forest as it was then, and is now

Naval timber

As we all know, timber has always been a valuable commodity, and the natural resources of the Royal Forest had been systematically conserved and managed throughout the medieval and early modern

period. The quality of timber produced was very high. There are records of grants by the Crown for beams to buildings of Oxford and elsewhere. In 1648 it was ordered that the 'great trees' of the forest were to be reserved for the navy for shipbuilding. In 1778 the



The Alfred Groves mill, circa 1970



A mobile steam crane on rails was necessary for the huge amount of timber requiring processing

navy bought 500 trees from Wychwood and later Nelson's ship *Victory* was built from oaks felled on Charlbury Commons.

As time passed, the royal coppices were leased out and by the late 17th century there was no overall management of the Forest to ensure that growth of timber in the coppices was encouraged. As a consequence, the quality of the timber declined so markedly that in 1807, Arthur Young, secretary to the Board of Agriculture, who was engaged in an ongoing survey, reported that: "I did not see one very fine tree of navy oak in a ride of 16 or 17 miles." Nevertheless, between 1807 and 1833, nearly 3,000 loads of timber – probably the equivalent of 1,500 trees – were taken from Wychwood Forest to the Royal Dockyards.

Drastic measures

By this time, the Wychwood region had also gained an evil reputation, as it provided hiding and protection for countless vagabonds and wrongdoers. Arthur Young commented that: "The vicinity is filled with poachers, deer-stealers, thieves and pilferers of every kind: offences of almost every description abound so much that the offenders are a terror to all quiet and well disposed persons; Oxford gaol would be uninhabited were it not for this fertile source of

crimes." In consequence, an act of parliament was passed in 1854 to clear the forest for agricultural land, a somewhat drastic measure. In a period of only 18 months, thousands of trees were cut down, areas of woodland and heath cleared, leaving only the present rump of woodland round Cornbury Park to the north east of Leafield.

The loss of the trees dramatically altered the landscape, a change still regretted by many to this day. In 1997 the Wychwood Project was established, with the aim of conserving the Wychwood landscape and increasing the levels of new woodland planting, both for its scenic qualities and as a haven for wildlife. Leafield participated in this by setting up its own Field Town Tree Planting Project, a step which has proved highly successful. Several farmers and other

landowners in Leafield and Langley have planted areas of native woodland and the Leafield Community Woodland has been established with trees grown from seed and planted by the children of Leafield School.

As has been touched on before, a major destination for the timber, be it oak, elm, beech, or ash, would have been for the British naval construction and would have been reserved for such. A tree was considered to not be worth cutting until it had been growing for 100 years. When cut, the timber for naval construction would have been taken about 20 miles by horse and cart to Eynsham, (shown on map), then loaded onto barges on the river Thames, then to the Port of London and the naval shipbuilding docks there. In just under 30 years during the early part of the 19th century, it's on record that about 1,500



Assorted sawn and sticked timber in perilous stacks



The gantry crane in use for sawn and unsawn timber



There's a limit to how much timber a one horse power cart can carry...



Unloading was a skilled job in itself

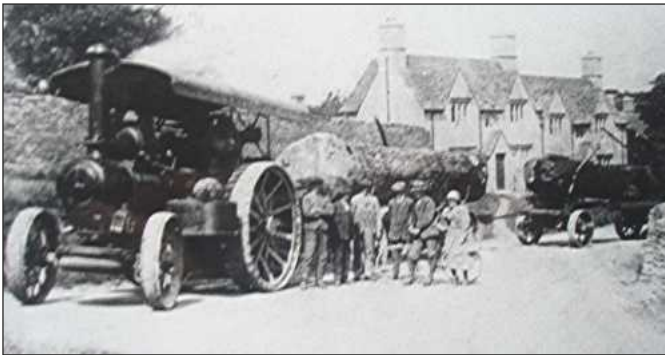

The traction engine enabled bigger loads to be carried for further distances. Note hand-powered brake levers on the tandem trailers



Post war transport became a much simpler affair for Alfred Groves & Sons



An extendable articulated trailer and cab made for heavier hauling



Early years in the joinery shop

trees of this stature had been cut and transported this way.

Early origins

It is believed that each of the Wychwood villages grew around a woodcutter's cottage, which was the start of the growth of the timber industry in the area. One of the greatest, if not the greatest, timber millers was Alfred Groves & Sons Ltd, who are to this day a building company specialising in restoration work, and can be traced back to their beginnings in 1660. To this day the timber mill is still owned by the original family descendants, together with several stone quarries and other concerns. Among their more recent projects have been the restoration of Gatcome House for H.R.H. The Princess Anne and Burford Priory, which recently sold for many millions. Much of the exquisite joinery – made at Alfred Groves' joinery shop and using local timber where possible – was installed in both. Tony Robinson recently had his *Time Team* at Burford Priory, doing one of their excavations, and will no doubt be on TV soon.

It is on record that at one time, Alfred Groves & Sons had the greatest stock of English oak in the country, all being sourced locally along with elm and other hardwoods.

However, there's generally a drawback to most success stories, and, in an early example of industrial pollution, for many

years the mill was responsible for a huge amount of sawdust, which was generally dumped anywhere and everywhere. There's an area not far from the mill that was excavated for sand at one period and then backfilled with tons and tons of sawdust; this land was later used for construction and piles or rafts had to be employed due to the unstable ground.

A more positive side effect of the timber milling was a generous supply of offcuts; some would have been used for weatherboarding and light building tasks, but possibly more important was the fact that the villagers could collect their fill of firewood for a few pence.

Photos show the large piece of land that was in use for timber storage along with the many buildings contained on the site. This company was the largest employer of men in the area at the time, and one of the largest commercial users of land for timber storage. Surrounding farms would have contributed significant numbers of trees as land clearance progressed and the timber mill would have purchased these and processed them as is the usual way of things.

Some timber was used as rubbing strakes at the cross channel ports on the South Coast, including Newhaven, Folkestone and Dover. These were timbers of hardwood, primarily elm, cross-sections of about 305-381mm square and took the brunt of ships when docking. This was

quite a long journey for the early lorries on the road in transportation.

Moving with the times

A lot of replanting was undertaken by the Government, but as the timber-built ships would eventually fade out before the maturity of the trees, it was to no avail and a lot of trees had to be left behind, which was no bad thing.

When the larger trees became a bit difficult to get hold of, towards the end of the 19th century and at the beginning of the 20th century, greater distances had to be travelled to find timber to keep the mill going.

The grandfather of a friend drove a traction engine for Groves' timber mill and made frequent trips to Wales, each of which took a week. The photo shown here (**top left**) depicts a traction engine with a tandem load behind, on one of those cross-country trips. Standing beside the engine are the crew of three, being the driver and two trailer brake men; the brakes would have been essential while navigating the many steep hills that lie west of Oxford.

With the advent of over-stripping of the best timber – nearly all oak – they had to go further and further afield for their needs and to keep the timber mill operating at full capacity.

For more information about the Wychwood Project, see their website: www.wychwoodproject.org. www



AIRPRESS

Veneering and Laminating Solutions

Veneer and laminate all your flat and curved panels with the UK's No.1 Vacuum press systems

Complete range of AirPress Vacuum Press Systems to suit every job and budget



Download your **FREE** step by step guide to vacuum veneering!
The 5 page guide is quick and easy to download from www.airpress.co.uk

Give us a call for advice and information 01725 514426 - sales@airpress.co.uk - www.airpress.co.uk



MULBERRY TREE WOOD TURNERY

HANDCRAFTED WOODEN BOWLS, PLATTERS AND HOLLOW FORMS

One to One beginner and intermediate bowl turning courses tailored to your needs...
...on the Beautiful Isle of Wight!

- Two students by arrangement.
- With registered professional Andy Fortune RPT.
- 5★ student rating on Tripadvisor.com, craftcourses.co.uk and facebook.com
- Gift Vouchers available.
- Supplier of tools, equipment, timber and finishing products.

- ✓ Supplier of hardwood and softwood timber and turning blanks
- ✓ Bespoke turning service
- ✓ Makers of handmade Bowls, Platters & Hollow Forms

Isle of Wight agents for Chestnut Finishing Products, Record Power tools and equipment and Robert Sorby tools



Robert Sorby Made in Sheffield England

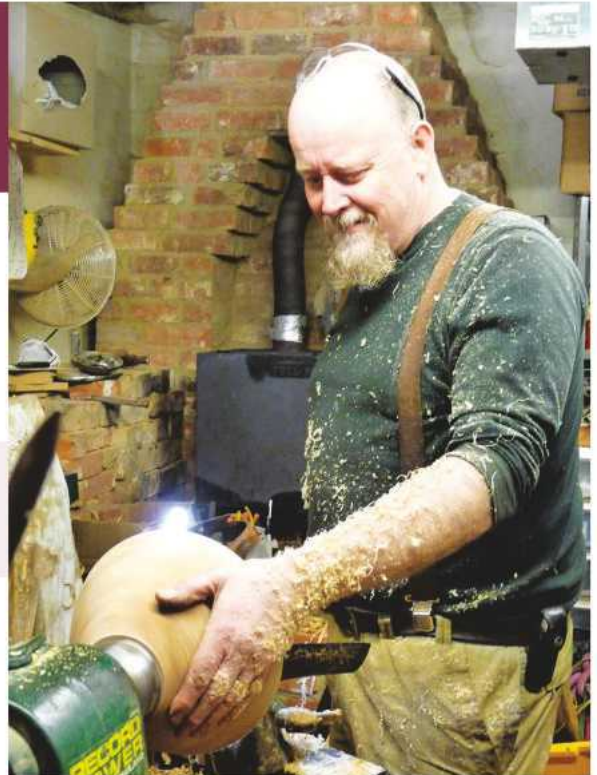

Mulberry Tree Wood Turnery • Arretton Barns Craft Village, Isle of Wight PO30 3AA
e: andy@mtwoodturnery.com • www.woodturnery.com • t: 01983 472696



Although at the lower end of the Nobex range, the Do It mitre saw represents great value for money and is more than adequate for most hobby use

Nobex Do It mitre saw

The Nobex Do It mitre saw is designed to cut timber (or, with the appropriate blade, PVC and aluminium) at a number of pre-set angles from 90-15°. The saw has a maximum depth cut of 110mm and will cater for wood 155mm wide at 90°; the width is then decreased down to 99mm at the maximum angle of cut.

Construction

The table is made of aluminium alloy with four plastic and chrome uprights. The feet are drilled so that the saw can be screwed down to a base but rubber feet are provided. The ribbed top surface is designed to take the dust so that the wood remains firmly on the table. The base is calibrated along the back edge in Imperial and Metric. The protractor is marked in degrees right and left and has six click stops for settings of 90 down to 15°.

A simple clamp holds the wood in place and can be moved from right to left as required; when positioned it is secured by tightening a knob. There is also a length stop for repetitive cutting.

The saw frame measures 700mm overall and takes Nobex blades measuring 565mm long. A standard general purpose hardpoint blade is provided but finer blades are available. A simple device holds the frame in the horizontal upright position up out of the way while adjustments are made to the cramping.



Assembly

The Nobex saw needs to be assembled when the parts are taken out of the box but following the instructions, this is a straightforward task. This saw is ideally suited to the hobby woodworker who wants to produce accurate mitres for frames, etc. Those wishing to produce segmented work will be able to cut wood accurately at pre-set angles repetitively. It should be noted that this saw is not designed for



The mitre saw's table is made of aluminium alloy with four plastic and chrome uprights



The built-in protractor is marked in degrees right and left and has six click stops



Once the correct angle is selected, the position is locked



A simple clamp holds the wood in place and can be moved from right to left as required

producing compound angles; if you wish to do this you will need to move up to the next model. This is a straightforward, simple device, which is easy to set up and the blades are quick to change. I personally like manual mitre saws because they are safe to use and I find powered chop saws intimidating! The stick-on feet proved to be reasonably efficient but I would probably choose to screw the saw down to a wooden base, which in turn could be cramped to the bench. This tool is rather difficult to store because of its shape, but it would be impractical to dismantle it each time after use.

In use

Wood to be sawn needs to be firmly clamped on to the saw table; holding it by hand is difficult and can reduce the accuracy of the cut. The simple clamping system is adequate but I tend to use a small F-clamp with soft jaws to clamp the wood to the back of the table.

When cutting small pieces I use a carefully prepared block of wood – again, clamped to the base to hold the block down. If you are cutting long pieces of wood, you may choose to support the end on the bench with a block so that the wood does not flex.

As long as the timber is first carefully prepared and gentle cuts are taken, good results will be obtained with the minimum of whiskering. Although some dust and shavings are inevitable, they are not scattered widely over the workshop.

In summary

The Nobex Do It mitre saw is constructed and finished to a high standard and should give many years of use. This model is at the lower end of the Nobex range but it is more than adequate for most hobby use and can be recommended. **IW**

SPECIFICATION

BLADE LENGTH	565mm
BLADE WIDTH	40mm
MAX CUTTING HEIGHT	110mm

VERDICT

A well constructed mitre saw with pre-set locking, which is quick and accurate. Great for the hobby user and built to last

- PROS**
- Accurate
 - Well constructed
 - Simple to set the angles

- CONS**
- None I can think of

VALUE FOR MONEY PERFORMANCE



FURTHER INFORMATION

- Axminster Tools & Machinery
- 0800 371 822
- www.axminster.co.uk



The saw frame measures 700mm overall and takes Nobex blades 565mm long

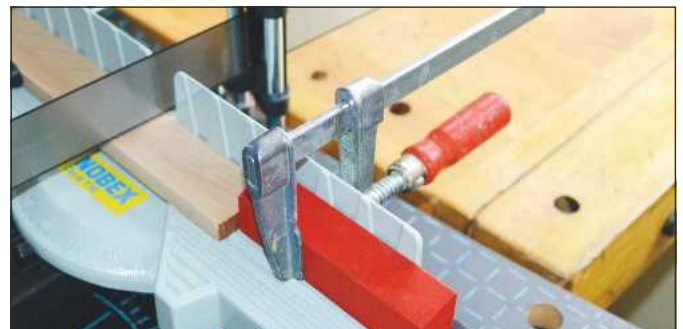

Wood to be sawn needs to be firmly clamped on to the saw table; holding it by hand is difficult and can reduce the accuracy of the cut



When cutting small pieces, I use a carefully prepared block of wood – again, clamped to the base to hold the block down

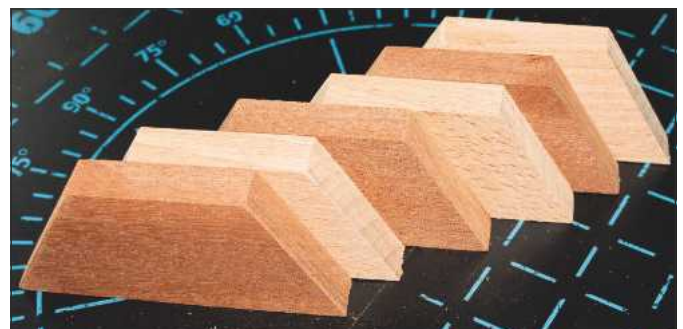

As long as the timber is first carefully prepared and gentle cuts are taken, good results will be obtained with the minimum of whiskering

New to the market, this Professional multi-tool from Bosch benefits from the innovative Starlock SDS system, which helps to make it even more quick, secure and convenient to use

Bosch GOP 40-30 Professional multi-tool featuring the Starlock SDS system

If ever there was a tool to come riding over the hills to save a tricky on-site situation like the Seventh Cavalry, it has to be the increasingly popular multi-cutter (aka the multi-tool). Originally developed for the health industry to safely remove plaster casts, it features a cutter blade which oscillates on such a short stroke (1.5° each side) that when it comes into contact with human tissue, it will only vibrate and not break the skin. Since the expiry of Fein's original patent in recent years, every manufacturer in town now has one on their books, and the Bosch Pro machine is as good an example as you will find anywhere.

Simple to use

As power tools go, the multi-tool is one of the simplest in working operation: just one switch turns it on or off, and it has an easy variable-speed to suit the job in hand. That said, though, a huge



variety of cutters, grinders and abrasive attachments means that its functionality is impressively enormous and makes it the versatile machine that every user knows it to be. The Bosch version is solidly built and feels somehow natural in the hand, nicely balanced and ready to go. Anyone (like me) who has been used to changing cutters with an Allen key (and the attendant fuss when it gets mislaid) will be delighted to learn that with this model and its new SDS innovation,



The old cutter is removed by simply pulling the SDS lever...



... and a new one fitted...



... by snapping it in



The 12-pointed star ensures maximum contact between cutter and tool...



... and the sprung jaws keep it firmly in place



The worklight in action; note short oscillation stroke



it's possible to fit a new cutter in only seconds. It really is impressive. First, the old blade can be swiftly jettisoned with a pull on the ejector lever (and without having to touch it too if it's red-hot), then a new cutter literally just snaps into place in a matter of moments. Oh, and the cutters themselves are made in Switzerland, which is a further indication of the best quality on this machine.

Speedy effectiveness

Simple though it is, in times of need the multi-cutter is the only tool for the job and most tradies won't go to site without one – whether they're dedicated woodworkers or not. I've been used to referring to my old multi-tool as the 'awkward saw' as it's generally called for whenever things are looking a bit dicey and normal methods can't be applied. So, when I took this new Bosch Pro version along to my latest fitting job, part of me was hoping it wouldn't be called into action. As it turned out it remained unused in its (very spacious) L-Boxx until practically the last minute when I noticed a protruding wedge on top of the giant wardrobe unit at the back. Giving silent thanks when I saw that the power lead was of a generous length (the extension lead having been packed onto the van already), I was further impressed with both the speedy effectiveness of the tool and especially the (previously unnoticed) worklight, which nicely pierced the under-ceiling gloom in the large bedroom.

In summary

All in all, the Bosch GOP 40-30 is a top quality tool, and one which is further enhanced by the quick-change SDS cutter system. **MC**



Just a few of the many different cutters and blades available



Close-up of the cleverly designed SDS lever – so simple to use

THE STARLOCK SYSTEM

As co-inventors of the SDS drill and chuck system in 1975 (which comes from Stecken Drehen Sichern or Insert Twist Secure, now Anglicised to Special Drill System) Bosch have a proven track record of innovation and improvement and have recently teamed up with Fein to develop a similar quick-change system for the multi-tool. This has been dubbed the Starlock system and is as quick, secure and convenient as you'd like it. As well as facilitating a rapid tool-free cutter change on the latest Bosch and Fein machines, the special cutters are backwards compatible with a large number of OMTs (other manufacturers' tools).

New corded & cordless multi-tools available

- GOP 55-36 Professional
- GOP 40-30 Professional
- GOP 30-28 Professional
- GOP 18V-28 Professional
- GOP 10.8V-28 Professional

Prices start from £94;
see www.bosch-professional.com

SPECIFICATION

NET WEIGHT	1.5kg
OSCILLATION RATE	8,000-20,000/min
OSCILLATION STROKE	3.0°
POWER	400W
CABLE LENGTH	4m
OSCILLATION ANGLE ON LEFT & RIGHT	1.5°
TOOL LENGTH	284mm

VERDICT

This new range of multi-tools featuring the Starlock SDS system is great and the model I tried, the GOP 40-30 Professional, was a top performer and difficult to fault

PROS ■ Smooth and powerful
■ Starlock cutters

CONS ■ None

VALUE FOR MONEY ■■■■■■
PERFORMANCE ■■■■■■

FURTHER INFORMATION

- Bosch Professional
- 03447 360 109
- www.bosch-professional.com

Instrument makers especially should welcome these planes from Veritas

Veritas detail palm planes

£33.43 each

SPECIFICATION

SOLE SHAPES	convex, double convex, concave or flat
SOLE SIZE	39 x 17mm
IRON WIDTH	10mm
HANDLE	bubinga

VERDICT

These specialist planes are lovely to use and are ideal for intricate shaping jobs

- PROS**
- Adjustable shaft
 - Easy to control
 - Good for finer control on smaller work

- CONS**
- Plane screw has to be completely removed to hone the iron

VALUE FOR MONEY

PERFORMANCE

FURTHER INFORMATION

- Axminster Tools & Machinery
- 0800 371 822
- www.axminster.co.uk

These are very competitively priced alongside their traditional brass counterparts, but have a couple of nice tricks up their sleeves to tempt you. Four sole configurations are available: a standard flat sole, concave, convex and double convex, each with a sole area of around 39 x 17mm with a 10mm-wide iron.

This range covers the same parameters as the violin-style planes, but with the inclusion of an extended neck, culminating in a bulbous bubinga handle that can be wound in and out by about 12mm to suit finger length. It definitely gives more push through a cut, and I felt it had finer control than just gripping the body only.

In use

It can also be used in more standard style by removing the whole of the handle stem and relying on finger and thumb grip alone to make the cuts.

Handle apart it's a simple construction much like the old-style Stanley block planes, so the iron is trapped against the bed by a small screw pushing the iron up against a retainer – in this case, grooves in the casting.

The small brass screw has to be removed to get the iron out for honing; no particular problem here, but remember that it's a left-hand thread.

The iron is A2 steel, ground to 30°. The thinness of the steel and the limited useable length warrant the need for retaining this as the cutting bevel rather



than a secondary honing one to ensure the longest lifespan.

The mouth fit is tight, and there's minimal, if any, lateral movement with the way the conical end of the retaining screw centralises it. Bear that in mind when honing or you could find the irons sitting askew to the mouth.

The hard steel should give a long life between hones, especially as they are used for small concentrated work rather than taking huge swathes of stock away.

In summary

Running chamfer edges and roundovers were nicely controllable, and the different base options proved handy when rolling out yet another boomerang for my dog, helping with the tighter radius work as well as hollowing the underside of the wings – maybe not what Veritas saw as its primary role, but they certainly make it easier!

These are cracking little planes, obviously specialist, but lovely to use and maybe not limited to instrument making; more intricate shaping jobs could be attempted with them, so apart from my boomerang making, they would work well alongside carving tools. **AK**



The handle can be removed to use as a finger plane



By unscrewing the top part of the handle the length can be extended



You have to remove the retaining knob to hone the iron



The planes are easy to control for finer detail



Here the convex plane is ideal for contouring the underside of a boomerang

If you're looking to add fine detail to flat stock, then this is the tool for you

Arbortech TurboShaft carving attachment

This bit of kit adds another string to the Arbortech's bow, allowing plunging cuts and finer detailing.

Designed to fit onto a standard mini grinder of 100mm or 114mm diameter capacity, the TurboShaft screws directly onto the grinder arbor with flats on the shaft, allowing a spanner to nip it up or remove it, although a suitable spanner isn't supplied with the kit.

A hollow adaptor bolt is supplied to alter the thread diameter to 10mm, if you own a grinder that doesn't have the more common 14mm thread for a direct fit.

Easy working

The tungsten carbide cutters can be rotated as they dull to keep the edge fresh and sharp and there's a Torx wrench supplied for this purpose.

Working with the TurboShaft is really easy: the twin circular cutting tips project marginally beyond the 20mm diameter shaft, which means the usual gyroscopic forces that can take effect with grinders fitted with wide discs is removed, so it's pretty controllable.

You need to ensure you use the side handle on your grinder for safe operation as you work but it's very easy to manoeuvre. With the cutting action limited to the tip of the shaft the cut isn't fast, but it can be used in a planing action to cut a recess or as a plunge cut and if you need to restrict the cut to a specific depth, there's also a substantial depth collar supplied.

The minimal cutter projection allows the TurboShaft to run against an edge so you can achieve template copying as well as freehand and with a cutting depth of around 70mm, you aren't limited to working the surface of any stock, either.

Best on dry stock

Having a bit of a tinker on an old pine fence post, I found it a little laborious to get past the woolly fibres and into the drier stuff below, but on doing so found the cut a lot easier and faster. Moving to a dry piece of flat stock, the performance was a marked improvement. I found it easier and cleaner cutting to drag the TurboShaft back through the work for sculpting and defining cuts, while moving in small clockwise circular motions when planing with the tip gave me good control, but it's not the tool you would reach for to remove a lot of timber; it took a while to drag out a shallow recess that would have taken seconds with an Arbortech – detailing is its forte.

In summary

I did find there was some vibration through to the grinder, but I only have a cheap DIY one so a better quality version should prove better here. Of course, as with any work that involves shaping and carving, the real art is in the initial design and seeing things in three dimensions before and as you progress removing the stock. The TurboShaft is a good addition for those who have such talent. **AK**



On drier stock the cuts were easy to make and control



SPECIFICATION

CUTTING DIAMETER	20mm
MAX PLUNGE DEPTH	70mm

VERDICT

Ideal for adding fine detail to flat stock and great for adding a touch of artistic flair to your woodcarvings

- PROS**
- Easy to control
 - Good for detail and plunging work

- CONS**
- Cuts quite slowly
 - Wet pine doesn't cut well

VALUE FOR MONEY	■■■■■■■■■■
PERFORMANCE	■■■■■■■■■■

FURTHER INFORMATION

- Axminster Tools & Machinery
- 0800 371 822
- www.axminster.co.uk



This brass adaptor is supplied for altering the thread diameter



The collar can be used to restrict the plunge depth of the tool



The cutters are made from solid tungsten carbide for durability



On softer, wet timber the TurboShaft struggled to cut

It would be more apt to call this versatile vice the Budgie as it is going so cheap

Axminster Trade Series Parrot Vice

In its vertical mode this vice resembles a lightweight swivelling engineering vice, but it can be lifted off its swivel post and used in a horizontal axis for great all-round access. It would be particularly useful for carving and for those who need to shape into an area to which access in normal



SPECIFICATION

MAX JAW CAPACITY	127mm
JAW WIDTH	89mm
IRON WIDTH	57mm
WEIGHT	7.5kg

VERDICT

All in all, a great vice at a great price. The only downside is the fear of cracking in certain areas

PROS

- Neat dual position for holding
- Swivels to best position

CONS

- Cast-iron anvil not ideal for striking

VALUE FOR MONEY

PERFORMANCE

FURTHER INFORMATION

- Axminster Tools & Machinery
- 0800 371 822
- www.axminster.co.uk

holding mode would be awkward.

In either vertical or horizontal plane it can be rotated 360° around the post and slid off it to reposition without the work having to be removed from the jaws; a neat function secures it tightly to the post when you are working.

Tightening up the jaws against the work and then applying a little more pressure has the double function of also nipping the vice to the post to hold it firmly so you can swivel to the best working position before locking fully off.

Backing off the pressure slightly still holds the work in the jaws but slackens the pressure on the post so that it can be rotated again or be taken off the post and reset to its secondary vertical or horizontal position.

Secure hold

The centre post is fitted to a three-toed foot with bolting holes through each so it can be secured directly to the bench top, or, if you need your top free of obstruction, to a mounting block that can be held in a standard bench vice or clamped to the top. Ideally, getting the vice really close to the corner of the bench allows longer or more intricate work to be swivelled over the edge.

Further holes in the jaws are useful for fitting flat or shaped timber jaw facings to

help secure work without leaving pressure marks. This limits the overall holding capacity of 127mm between the jaws, but is worthwhile if you are working on a more delicate piece.

The quality of the castings appears very good, while the Acme-threaded vice screw, although looking a little more 'budget', operates pretty freely and easily.

In summary

It's certainly a great vice, for working shaped stuff especially, and proved ideal when making yet another boomerang for my dog to chase – they do come back but he loses track of them and then chews them up when he spots them!

My only concern is the cast grey iron construction alongside the small anvil area behind the jaws as I fear this could crack with regular whacks. **AK**



The easily secured vice slips onto the post and self locks once tightened against the work



It simply slides off the post for repositioning in the horizontal mode



Shaping work with a spokeshave on the pull or push stroke



Set horizontally it allows you to work at the best position

TIMBER SUPPLIES, COURSES & SPECIALIST EQUIPMENT

Allan Calder's Ltd
Sandpaper Supplies

Unit 2B, Churnet Works, James Brindley Road, Leek, Staffordshire ST13 8YH.



We are supplying top quality brands of sanding abrasives for all types of Wood Turners, Joiners & Cabinet Makers.

Web: www.sandpapersupplies.co.uk

email: sandpapersupplies@yahoo.co.uk

Tel: **01538 387738**

Woodturning & Woodworking Courses

One or two day courses available

Just Wood Norfolk

By Tutor with over 30 years experience in wood turning, cabinet making, antique restoration, wood machinery, joinery and the timber industry.

Courses arranged to suit & situated in Norfolk
Please call for more details.

Telephone Peter on **01493 782408** • e: luckymayhew@gmail.com
or see our website: www.justwoodnorfolk.co.uk for more details

THE CHIPPENDALE INTERNATIONAL SCHOOL OF FURNITURE



Thirty years teaching furniture design, making and restoration



www.chippendaleschool.com

Unloved?
Unuseable?
RESTORE IT!

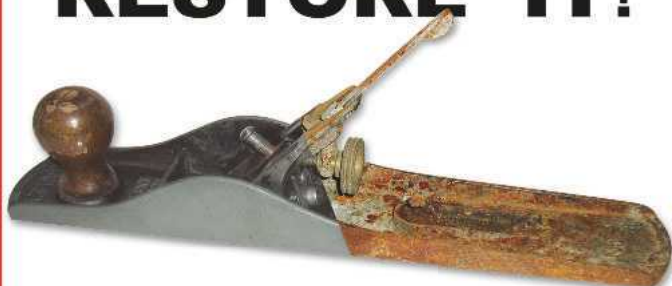

Stanley No.5 'before & after' photo courtesy Peter Hemsley – The ToolPost

Restore Rust Remover & Restore Rust Remover Gel
Remove *only* the rust leaving sound metal unaffected. Cleans and brightens brass and nickel plating. See more stunning 'before & after' examples on our website photo galleries. Find local and international stockists on the website.

Shield Technology Limited.
Unit 69, Grimsby Business Centre
King Edward Street,
Grimsby, DN31 3JH

Tel: +44 (0)1472 360699
Fax: +44 (0)1472 324685
Email: info@shieldtechnology.co.uk
www.shieldtechnology.co.uk

Distributor enquiries welcome

SHIELD TECHNOLOGY
Guarding Against Corrosion

SURREY TIMBERS Ltd

Your One-Stop Wood Shop

Hardwood Timber Merchant
stocking local & Imported Timber



Buy one piece or one pack!

Please come & select from our range:

OAK, YEW, WALNUT, SAPELE, APPLE, MAPLE, SYCAMORE & More!

All welcome • Woodturners • Joiners, Cabinetmakers
Call in and see our huge range at: Loseley Park, Guildford GU3 1HS

01483 457826 or 07795 663792

www.surreytimbers.co.uk

WOOD TURNING, SPECIALIST TOOLS & EQUIPMENT

BLACK ISLE WOODTURNING 

 The UK's exclusive agent for Vicmarc machinery



- Lathes
- Chucks
- Jaws
- Accessories & Spares
- RP400 Chuck Spares & Jaws

Woodturning supplies, tools & tuition

Tel: **07842 189 743**

 e: info@blackislewoodturning.com 

www.blackislewoodturning.com

MAIL ORDER
NARROW BANDSAW
BLADES
MANUFACTURED TO
ANY LENGTH
PHONE NOW FOR QUOTATION
OR PRICE LIST
TRUCUT

Spurside Saw Works, The Downs,
 Ross-On-Wye, Herefordshire HR9 7TJ
www.trucutbandsaws.co.uk
Tel: 01989 769371
Fax: 01989 567360

TOP QUALITY - LOW PRICES!
VSM VITEX ABRASIVES
KK532F Starter Pack (4 Metres) £14.00
 Inc.VAT & UK post. ½ metre each of grit 80, 120, 150, 180, 240, 320, 400 and 600.
***GRIP-A-DISC* Power Sanding System**
 50mm Starter Kit - **£32.00** Inc.VAT & post. Contains 50 Discs and Holder.
We also stock: Sorby Tools, Chestnut Products, Pacer Super Glues & VSM belts.

SAE for Catalogue
Jill Piers Woodturning Supplies
 2 Kimberley Villas, Southmill Road,
 BISHOP'S STORTFORD, HERTS. CM23 3DW
Tel/Fax: 01279 653760

TS111 Shopsmith
Table saw fence Inkra
For Sale

In good condition & well maintained
Buyer MUST collect
Only £250 or any reasonable offer
 Telephone: **01923 256 466** (Watford)

FOR SALE
£200 the lot!
Carpenter's workshop tools
(due to career change)
ELECTRA BECKUM
All in good working order!

- Air Compressor
- Planer Thicknesser
- Elektra Beckum Type SPA 1100 Single Bag Dust Extractor HDM 1000
- Wood Chisels set
- **Many other valuable items**

These can be viewed at any time, Buyer must collect and I am open to offers.

A.Kasem (07796 151905)
 Morden, Surrey

www.StarkieSharp.com
 The Diamond Sharpening Specialists



- Better Prices
- More Information
- Visit us at 40+ Shows

DMT
Diamond Sharpening Perfection!

Much safer, smoother carving with up to 44 Teeth cutting fast at 10,000+ RPM.

KATS
 Chainsaw Discs
The Ultimate Power Carving Experience!
 Cut, Carve, Shape, Notch, Trench & Groove in Seconds!
 Massively increases productivity!

Quote Code **SSGWD6** at checkout for **FREE** Universal Nut worth **£6.95**

Shown Lancelot & Squire in Tandem
 Richard Starkie Associates, www.StarkieSharp.com
 Timber Cottage, Wistow, Leicester, LE8 0QF Email: sales@starkies.com

COURSES & PLANS, TIMBER SUPPLIES & SPECIALIST EQUIPMENT



The original milk paint, for authentic colour in all your woodworking and restoration projects.

Quote 'WWoffer' for 10% off your first order

The Blueberry Store

New England Interiors
Folk Art-Americana

www.blueberrystore.co.uk

TOOLS WANTED

Top Prices Paid For Quality Hand Tools
carving tools, chisels, turning tools
norris planes (and similar), metal planes
green tools, any nice old hand tools...

email photos to: info@oldtools.co.uk
or bring tools to: Bexhill - 01424 217893



TREE STATION

Quality English Sawn Timber:

- » Rough sawn or planed
- » Wide variety of species and thicknesses
- » Sustainably grown and kilned



Please get in touch or visit our website
www.treestation.co.uk - 0161 2313333

Tewkesbury Saw Company Ltd

Spindle Moulder Cutters & Limiters

Made to Order!

- Quick turnaround
- Able to supply to fit most types of blocks
- Many low priced standards from stock

Tewkesbury Saw Co. Ltd.
Newton Trading Est. Tewkesbury, Glos. GL20 8JG
Tel: 01684 293092 • Fax: 01684 850628
www.tewkesburysaw.co.uk

ANDREW CRAWFORD BOX MAKING COURSES

What an adventure! Andrew is a true master of the craft, and expertly shared and showed us how to reach new levels of craftsmanship!

- ◆ weekend courses
- ◆ 'gold' 5 day courses
- ◆ one-to-one tuition

www.box-making.com ◆ 01694 781318



SHOP GUIDES

Visit our website at www.hobbyuk.com

HOBBY'S
The Modelmaker's Yearbook
Annual 2016 • No.46 • 320 Pages
£3.25 P&P FREE

- NEW EASY CUTTERS & POWER TOOLS
- MECHANICAL ALARM CLOCK KIT
- NEW ICONIC TV/FILM KITS
- HERITAGE STEAM ENGINE
- MARQUETRY KITS WITH DVD

DOLLS HOUSE SPECIALISTS

MATCHITECTURE
ONE THOUSAND AND ONE NIGHTS
NEW ARTICLES
METAL EARTH HANDSOME CAB MATCHSTICK CLOCK

FREE PLAN COUPON
WORKING MATCHSTICK ROCKING HORSE

Hobby's (Dept WW)
Knight's Hill Square
London SE27 0HH
020 8761 4244
mail@hobbyuk.com
www.hobbyuk.com

Available from WH Smith & leading newsagents or direct

TOP QUALITY - LOW PRICES!

VSM VITEX ABRASIVES

KK532F Starter Pack (4 Metres) £14.00
Inc. VAT & UK post. ½ metre each of grit 80, 120, 150, 180, 240, 320, 400 and 600.

***GRIP-A-DISC* Power Sanding System**
50mm Starter Kit - £32.00 Inc. VAT & post. Contains 50 Discs and Holder.

We also stock: Sorby Tools, Chestnut Products, Pacer Super Glues & VSM belts.

SAE for Catalogue

Jill Piers Woodturning Supplies
2 Kimberley Villas, Southmill Road,
BISHOP'S STORTFORD, HERTS. CM23 3DW
Tel/Fax: 01279 653760

BERKSHIRE

WOKINGHAM TOOL COMPANY LTD

97-99 Wokingham Road
Reading, Berkshire RG6 1LH
Tel: 0118 966 1511
www.wokinghamtools.co.uk
H. P. W. CS. BS. A. D. MO.

LEEDS

D.B. KEIGHLEY MACHINERY LTD
Vickers Pleace, Stanningley,
Leeds, LS28 6LZ
Tel: (0113) 257 4736
Fax: (0113) 257 4293
www.dbkeighley.co.uk
P. A. CS. BC. MO.

JET **SIP** **SEDGWICK**

WEB GUIDE

WEALDEN TOOL COMPANY

Router cutters
Spindle tooling
Bandsaw, jigsaw & circular sawblades

Online catalogue & ordering
www.wealdentool.com

www.getwoodworking.com

COURSES

Woodworking courses
in idyllic Herefordshire countryside...

...for beginners and improvers

- Personal tuition (max. 2 learners) from qualified teacher with 40 years' furniture-making experience
- Well-equipped heated workshop
- Superb setting, with spectacular views
- Luxury farmhouse accommodation with excellent food - see our **Tripadvisor 5★ ratings!** Or you can camp in the woods!!

www.littletrewern.co.uk/woodworking
Tel: 01873 860749 • email: woodworkingbreaks@gmail.com

MUSICAL INSTRUMENT MAKERS

Musical Instrument Makers' & Repairers' Supplies

TOUCHSTONE TONEWOODS

Largest selection of tonewoods, tools & parts in the country.
Visit our website or order our catalogue. Callers welcome

Touchstone Tonewoods, Albert Road North, Reigate, RH2 9EZ
Tel: 01737 221064 Fax: 01737 242748
www.touchstonetonewoods.co.uk

WOOD VENEERS



The Wood Veneer Hub
www.thewoodvenerhub.co.uk

We provide the highest quality:

Decorative, Exotic & Burr Veneers
Coloured & Smoked Veneers
Constructional Veneers
Peel & Stick Veneers
Tools & Accessories

Visit Us: Unit 4 Eden Court, Eden Way
Leighton Buzzard, Bedfordshire, LU7 4FY
+44 (0) 1525 851166
sales@thewoodvenerhub.co.uk

CLOCKS

Woodworking Materials
Large selection of products!

- ✓ Clocks & Accessories (Quartz and Mechanical)
- ✓ Barometers
- ✓ Thermometers
- ✓ Cabinet furniture
- ✓ Screws
- ✓ Plans
- ✓ Kits
- ✓ Polishes
- ✓ Adhesives
- ✓ Abrasives etc.

For **FREE** catalogue please contact:

Chris Milner Woodworking Supplies
(Dept. TW) Beresford Lane, Woolley Moor, Nr. Alfreton Derbyshire DE55 6FH
Tel/fax: (01246) 590 062
Email: milnerwoodwork@aol.com

To advertise here...
...call David on **01689 869 867**
david.holden@mytimemedia.com

MARKETPLACE

Our FREE classified advertisement service



FOR SALE

Nu Tool woodturning lathe, 1,400mm long, 300 x 850mm capacity, cast-iron, steel stand, swivelling headstock, variable-speed, 230V motor, rests, centres, chucks, faceplates, spanners, 10 HSS turning tools – excellent condition; £295 ONO
01733 571 763 (Peterborough)

Apollo wood lathe – Professional model. Spindle – 2MT; tailstock – 2MT, swivel headstock, variable-speed and reverse; 240 electric; 8in swing over bed; 14in outboard; 42in between centres. With four-prong drive, small faceplate, toolrest, heavy-duty centre steady and two chucks; £395 OVNO
07816 371 694 (Northumberland)

Jet JSSG-10 wet sharpener with profile leather wheel and cloth cover and a further nine accessories; £210 ONO. Axminster mortiser BM785 with metal stand and wheels, 1/4-1/2 bits and sharpener set, plus dovetail bit 5/8-1/2; £230 ONO. Buyer collects
01293 406 056 (West Sussex)

Four Good Woodworking binders, in good condition; £15
01902 762 188 (Wolverhampton)

A complete range of woodworking tools and equipment used for violin, guitar and cabinetmaking, all of which are in excellent or like new condition
01672 520 020 (Marlborough)

Good Woodworking magazines, issues 100-169 (Autumn 2000 to December 2005). Free to anyone who can collect (Crieff) or pay shipping
01764 652 016 (Perthshire)

Teak shop counter heavy construction: legs 75 x 75mm; top from 50 x 200mm boards; £25
01225 388 570 (Bath)

The Complete Guide to Joint-Making by John Bullar; £10; *Routers & Router Tables* by Fine Woodworking; £10; *Woodworking with the Router* by Bill Hynton; £20. Unused, brand-new
01375 891 893 (Essex)

Wadkin pattern-maker's vice (UPV61). Good working order, buyer collects
07722 586 974 (Whittlesey)

Chisels, planes, gouges, dividers, drills, screws (in boxes), picture framing, cupboard doors/shelves, hinges, vice, saws, various wood, and more. Open to offers
01162 783 264 (Leicester)

Old woodworking tools including Slater, Ibbotson, Preston, Marples and Spear & Jackson; phone for details and prices
01628 625 836 (Maidenhead)

Workshop timber clearance. Hardwoods and softwoods, plus some boards; £100 for everything
01767 640 624 (Beds)

Elektra Beckum/Metabo planer/thicknesser HC260, in mint

condition; £375; 10in Shipmate radial arm saw; £150
01873 812 498 (Powys)

Record Bandsaw BS400 as new, depth of cut – 12in; width of cut – 16in; £500. Hegner Multicut 52 variable-speed, in excellent condition; £300
01777 870 309 (Newark)

Good Woodworking magazines, Nos 1-177, inclusive; £50 ONO – buyer collects
01460 394 234 (Somerset)

Shopsmith Mk5 lathe complete with bandsaw, jointer, circular saw with spare tipped blade, moulder, sanding disc, extended table, plus many extras. Call to make an offer
01476 561 966 (Lincs)

Lie-Nielsen No.85 cabinetmaker's scraper plane, used once as new, boxed; £130 and Veritas bronze edge plane, rare and in lovely condition; £90
01992 620 9961 (Herts)

Charnwood chuck to fit Nova thread; £50; numerous turning tools; £190; 56lb 6in ceramic tiles; £42; eight books; £5 each; eight acrylic pen holders; £28; chainsaw bib and brace, plus helmet; £65, buyer collects
01209 211 522 (Cornwall)

Woodworker magazines (Nov 1944-Mar 1953). Excellent condition for their age; offers considered
01372 374 587 (Surrey)

Clifton planes for sale: No.4; £130; No.5; £140; No.4 1/2 (brand-new); £155; No.6; £160
07818 410 591 (County Durham)

Carpenter's marking gauges (2) brass and rosewood; £35, plus Stanley No.505 combination plane with set of blades in original box; £55
0208 641 4238 (Surrey)

Coronet Minor M6 lathe plus chisels and some accessories, with new control switch; £130 ONO
01189 573 669 (Reading)

WANTED

Woodworker magazines. Pre-1951 plus 1984-1986. Grandfather collecting for cabinetmaker grandson
01493 368 180 (Norfolk)

Spiers/Norris/Henley planes wanted by private collector; any quote beaten. Ring Ron Lowe on
01530 834 581 (Leics)

Woodworking hand tools, especially old wood and metal planes, wanted by collector. Write to Mr B Jackson, 10 Ayr Close, Stamford PE9 2TS or call
01780 751 768 (Lincs)

Woodworking tools: planes by Norris, Spiers, Mathieson, Preston, Slater, etc. brass braces, interesting rules and spirit levels; top prices paid, auction prices beaten
01647 432 841 (Devon)

USE THIS FORM TO BOOK YOUR FREE AD

The Woodworker
MARKETPLACE & Woodturner

- This space is available only to private individuals wishing to buy or sell woodworking machinery and tools.
- The maximum value of any item for sale must not exceed £500. A small fee is payable for items offered at over £500; please ring 01689 869 852 for details.
- Each coupon is valid for one free insertion in the next available issue.
- The publisher accepts no responsibility for errors or omissions in this section.

Name _____
Address _____

Postcode _____ Daytime tel no. _____
Signature _____

Please publish this advertisement in the next available edition of *The Woodworker*. I am a private advertiser and have no trade connections.

PLEASE TICK: FOR SALE WANTED

My advertisement (max 20 words please) reads as follows:

Please write your advertisement in **BLOCK CAPITALS** and send it to: *The Woodworker* Marketplace, MyTime Media Ltd, Enterprise House, Enterprise Way, Edenbridge, Kent TN8 6HF. You can also email your free ad to: tegan.foley@mytimemedia.com Send/email a photograph of your item and we'll include it with your ad for FREE

A handful of dust



Join us on the back page as we share the first installment of one reader's experiences as a trainee in a busy London furniture factory shortly after the war

Just to set the record straight from the outset, I was an employee at Harris Lebus Ltd, and my story is rather simple. From 1941 to 1945 I attended Down Lane Central School, which was just around the corner from the Harris Lebus Factory at Tottenham Hale. Both factory and school are now no more. My Father came from County Durham (the North East of England) and instilled in me: "White collar job for thee, lad, tha' not getting tha' bloody hands dirty." Among many other platitudes and expressions which I still use today.

A fortunate life

I have been very fortunate in my life by having a succession of good teachers, especially at Down Land Central School, Tottenham, where my love of the English language and mathematics were encouraged and fostered, to the extent that I achieved Stages 1 and 2 in both subjects in the Royal Society of Arts examinations before leaving school at the age of 15 years and six months.

When I left school I was employed by The Westminster Bank Ltd at 53 Threadneedle Street in the City of London. My parents and teachers were all highly delighted at this, especially as I had obtained this appointment by my own efforts. I started work earning a

princely sum of £1.18.6 (£1.93) a week, from which I had to buy my daily fare into the City of London, my lunches and give my mother a contribution. From my paper round I earned £1.10.0 (£1.50) plus tips of at least the same amount, making my part-time income some £3 a week! Some of my friends could not understand why I kept my paper round going until after Christmas. They did not seem to understand that I could even double my tips in that week!

'Called to the colours'

At 18 years of age I was 'called to the colours'. I had to serve two years' National Service, which I did as a member of His Majesty's Royal Air Force, Coastal Command, stationed at RAF Ballykelly, Northern Ireland. I was a Radio Telephony Operator (Direction Finding) – a radio trade – and in that time I rose to the dizzy height of Corporal. I am told that a Serving Regular Airman takes about five years to attain that rank! On demobilisation the thought of

returning to a clerical life was a bit horrifying so I marched into Tottenham Labour Exchange and announced that I had decided to 'go into industry'. They sent me to Harris Lebus Ltd, which, at some 30 acres in extent and employing some 3,500 employees, was the biggest furniture factory in the world. I do not think it has been surpassed.

This company was often referred to as 'the Ford of the furniture world', because it was highly organised and extremely efficient. The production in the 1950s was 1,000 suites a week. A suite comprises three pieces of furniture, so the output was actually some 3,000 pieces of furniture a week, or 600 pieces a day. Many years later I worked in Ford's tractor plant at Basildon in Essex and was able to compare the two units. Lebus wins, in my opinion, because each employee was enabled to earn more than the standard rate of pay, dependent upon the skill and effort they applied to their task – in other words, 'payment by results', or piecework. **WW**

NEXT MONTH

© Peter Baker 2016

Join us next month as Peter starts his woodworking career. And if any other readers have a story to tell, we'd be glad to listen. Just write to mark.cass@mytimemedia.com and we'll see how we get on



One Workcentre Many Tasks

TWX7 Workcentre Systems

The TWX7 brings the precision and convenience of the legendary Triton Workcentre to a new generation. Constructed using lightweight yet robust extruded aluminium sections, which support innovative low-friction work surfaces, the TWX7 is the ideal solution for the woodworking enthusiast. In addition the all new TWX7 is now a highly capable and mobile multi-purpose workshop for professional site use.



Router Table Module Precision router table & fence with featherboards



Contractor Saw Module Powerful & accurate table saw with full length fence

TWX7
Workcentre



Clamping Table Module
Clamping table supplied as standard
with 120kg working load



Optional Modules

TWX7 RT001
Router Table Module



TWX7 CS001
Contractor Saw Module



Introducing the New Range of Woodturning Chucks and Jaws

We are extremely proud to introduce the new range of Record Power woodturning chucks and jaws. This exclusive range has been developed using Record Power's extensive experience and knowledge of woodturning in conjunction with a group of highly experienced professional and hobby woodturners to bring you the ultimate in quality, versatility and value.



Precision Engineered Gears
Super Geared True-Lock™ technology ensures high levels of accuracy to provide smooth and solid operation.



Jaw Fixing System
The SC3 and SC4 feature a jaw fixing which will not only fit the Record Power series of Jaws but is also fully compatible with Nova and Robert Sorby brand jaws.

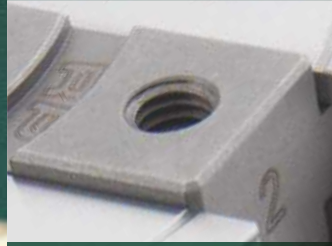

Heavy Duty Jaw Slides
The improved and enlarged jaw slides give unsurpassed holding power and load bearing ability. They are made from high tensile steel, reinforced with nickel and copper and heat-treated to ensure superior strength.



Sealed Backing Plate with Full Indexing
The SC4 features a strong backing plate to protect the gear mechanism from dust and 72-point indexing around the full circumference.

SC3 Geared Scroll Chuck Package **Only £99.99**
Now includes 2" Faceplate

SC4 Professional Geared Scroll Chuck Package **Only £129.99**
Now includes 2" Faceplate

15% OFF
All jaws when 3+ sets bought

Prices valid until 31.8.2016

See online for full details

RECORD POWER
ESTABLISHED 1909®

Over
100
years
Experience • Knowledge
Support • Expertise

RECORD POWER
ESTABLISHED 1909
STARTRITE
CORONET
BURGESS

Incorporating some of the most famous brands in woodworking, Record Power have been manufacturing fine tools & machinery for over 100 years. Built to last we provide support for thousands of machines well over 50 years old, which are still in daily use. Testimony to the sound engineering principles and service support that comes with a Record Power product.

www.recordpower.co.uk Tel: 01246 571 020